

TPS76030, TPS76032, TPS76033, TPS76038, TPS76050 LOW-POWER 50-mA LOW-DROPOUT LINEAR REGULATORS

SLVS144B – JULY 1998 – REVISED FEBRUARY 1999

- 50-mA Low-Dropout Regulator
- Fixed Output Voltage Options: 5 V, 3.8 V, 3.3 V, 3.2 V, and 3 V
- Dropout Typically 120 mV at 50 mA
- Thermal Protection
- Less Than 1 μ A Quiescent Current in Shutdown
- -40°C to 125°C Operating Junction Temperature Range
- 5-Pin SOT-23 Package
- ESD Protection Verified to 1.5 kV Human Body Model (HBM) per MIL-STD-883C

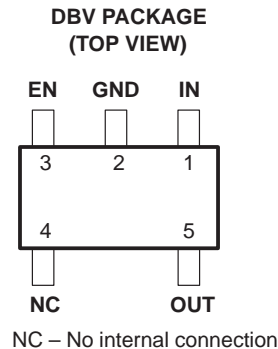

description

The TPS760xx is a 50mA, low dropout (LDO) voltage regulator designed specifically for battery-powered applications. A proprietary BiCMOS fabrication process allows the TPS760xx to provide outstanding performance in all specifications critical to battery-powered operation.

The TPS760xx is available in a space-saving SOT-23 package and operates over a junction temperature range of -40°C to 125°C .

AVAILABLE OPTIONS

T_J	VOLTAGE	PACKAGE	PART NUMBER	SYMBOL
-40°C to 125°C	3 V	SOT-23	TPS76030DBVR	PAGI
	3.2 V		TPS76032DBVR	PAOI
	3.3 V		TPS76033DBVR	PAHI
	3.8 V		TPS76038DBVR	PAJI
	5 V		TPS76050DBVR	PANI

NOTE: The DBV package is available taped and reeled only.

functional block diagram

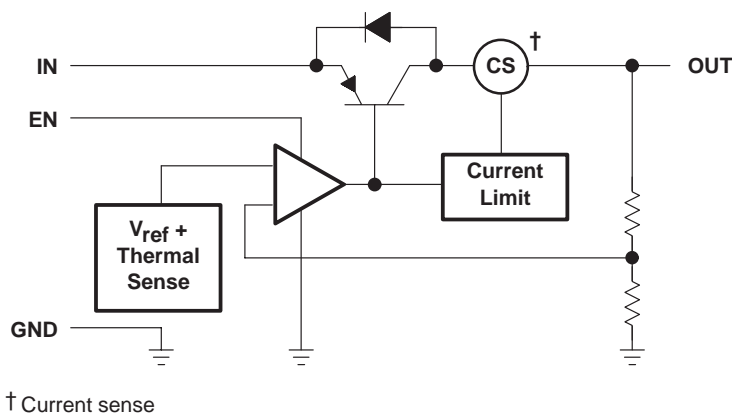

Please be aware that an important notice concerning availability, standard warranty, and use in critical applications of Texas Instruments semiconductor products and disclaimers thereto appears at the end of this data sheet.

PRODUCTION DATA information is current as of publication date. Products conform to specifications per the terms of Texas Instruments standard warranty. Production processing does not necessarily include testing of all parameters.

**TEXAS
INSTRUMENTS**

POST OFFICE BOX 655303 • DALLAS, TEXAS 75265

Copyright © 1999, Texas Instruments Incorporated

TPS76030, TPS76032, TPS76033, TPS76038, TPS76050

LOW-POWER 50-mA LOW-DROPOUT LINEAR REGULATORS

SLVS144B –JULY 1998 – REVISED FEBRUARY 1999

Terminal Functions

TERMINAL NAME	NO.	I/O	DESCRIPTION
IN	1	I	Input voltage
GND	2		Ground
EN	3	I	Enable input
NC	4		No connection
OUT	5	O	Regulated output voltage

absolute maximum ratings over operating free-air temperature range (unless otherwise noted)†

Input voltage range, V_I ‡	–0.3 V to 16 V
Voltage range at EN	–0.3 V to $V_I + 0.3$ V
Peak output current	internally limited
Continuous total dissipation	See dissipation table
Operating junction temperature range, T_J	–40°C to 150°C
Storage temperature range, T_{stg}	–65°C to 150°C
ESD rating, HBM	1.5 kV

† Stresses beyond those listed under “absolute maximum ratings” may cause permanent damage to the device. These are stress ratings only, and functional operation of the device at these or any other conditions beyond those indicated under “recommended operating conditions” is not implied. Exposure to absolute-maximum-rated conditions for extended periods may affect device reliability.

‡ All voltages are with respect to device GND pin.

DISSIPATION RATING TABLE

	PACKAGE	$T_A \leq 25^\circ\text{C}$ POWER RATING	DERATING FACTOR ABOVE $T_A = 25^\circ\text{C}$	$T_A = 70^\circ\text{C}$ POWER RATING	$T_A = 85^\circ\text{C}$ POWER RATING
Recommended	DBV	350 mW	3.5 mW/°C	192 mW	140 mW
Maximum	DBV	437 mW	3.5 mW/°C	280 mW	227 mW

recommended operating conditions

		MIN	NOM	MAX	UNIT
Input voltage, V_I	TPS76030	3.2		16	V
	TPS76032	3.4		16	V
	TPS76033	3.5		16	V
	TPS76038	4		16	V
	TPS76050	5.2		16	V
Continuous output current, I_O		0		50	mA
Operating junction temperature, T_J		–40		125	°C



TPS76030, TPS76032, TPS76033, TPS76038, TPS76050 LOW-POWER 50-mA LOW-DROPOUT LINEAR REGULATORS

SLVS144B –JULY 1998 – REVISED FEBRUARY 1999

**electrical characteristics over recommended operating free-air temperature range,
 $V_I = V_{O(nom)} + 1\text{ V}$, $I_O = 1\text{ mA}$, $EN = V_I$, $C_O = 2.2\text{ }\mu\text{F}$ (unless otherwise noted)**

PARAMETER		TEST CONDITIONS	MIN	TYP	MAX	UNIT	
V_O	Output voltage	TPS76030	$T_J = 25^\circ\text{C}$	2.96	3	3.04	V
			$T_J = 25^\circ\text{C}$, $1\text{ mA} < I_O < 50\text{ mA}$	2.92		3.04	V
			$1\text{ mA} < I_O < 50\text{ mA}$	2.91		3.07	V
		TPS76032	$T_J = 25^\circ\text{C}$	3.16	3.2	3.24	V
			$T_J = 25^\circ\text{C}$, $1\text{ mA} < I_O < 50\text{ mA}$	3.13		3.24	V
			$1\text{ mA} < I_O < 50\text{ mA}$	3.1		3.3	V
		TPS76033	$T_J = 25^\circ\text{C}$	3.26	3.3	3.34	V
			$T_J = 25^\circ\text{C}$, $1\text{ mA} < I_O < 50\text{ mA}$	3.23		3.34	V
			$1\text{ mA} < I_O < 50\text{ mA}$	3.2		3.4	V
		TPS76038	$T_J = 25^\circ\text{C}$	3.76	3.8	3.84	V
			$T_J = 25^\circ\text{C}$, $1\text{ mA} < I_O < 50\text{ mA}$	3.73		3.84	V
			$1\text{ mA} < I_O < 50\text{ mA}$	3.7		3.9	V
		TPS76050	$T_J = 25^\circ\text{C}$	4.95	5	5.05	V
			$T_J = 25^\circ\text{C}$, $1\text{ mA} < I_O < 50\text{ mA}$	4.91		5.05	V
			$1\text{ mA} < I_O < 50\text{ mA}$	4.89		5.1	V
$I_{I(\text{standby})}$	Standby current	$EN = 0\text{ V}$			1	μA	
	Quiescent current (GND current)	$I_O = 0\text{ mA}$, $T_J = 25^\circ\text{C}$		90	115	μA	
		$I_O = 0\text{ mA}$			130		
		$I_O = 1\text{ mA}$, $T_J = 25^\circ\text{C}$		100	130		
		$I_O = 1\text{ mA}$			170		
		$I_O = 10\text{ mA}$, $T_J = 25^\circ\text{C}$		190	215		
		$I_O = 10\text{ mA}$			460		
		$I_O = 50\text{ mA}$, $T_J = 25^\circ\text{C}$		850	1100		
		$I_O = 50\text{ mA}$			1200		
Input regulation		TPS76030	$4\text{ V} < V_I < 16$, $I_O = 1\text{ mA}$		3	10	mV
		TPS76032	$4.2\text{ V} < V_I < 16$, $I_O = 1\text{ mA}$		3	10	
		TPS76033	$4.3\text{ V} < V_I < 16$, $I_O = 1\text{ mA}$		3	10	
		TPS76038	$4.8\text{ V} < V_I < 16$, $I_O = 1\text{ mA}$		3	10	
		TPS76050	$6\text{ V} < V_I < 16$, $I_O = 1\text{ mA}$		3	10	
V_n	Output noise voltage	$BW = 300\text{ Hz to } 50\text{ kHz}$, $C_O = 10\text{ }\mu\text{F}$, $T_J = 25^\circ\text{C}$		190		μVrms	
	Ripple rejection	$f = 1\text{ kHz}$, $C_O = 10\text{ }\mu\text{F}$, $T_J = 25^\circ\text{C}$		63		dB	
Dropout voltage		$I_O = 0\text{ mA}$, $T_J = 25^\circ\text{C}$		1	3	mV	
		$I_O = 0\text{ mA}$			5		
		$I_O = 1\text{ mA}$, $T_J = 25^\circ\text{C}$		7	10		
		$I_O = 1\text{ mA}$			15		
		$I_O = 10\text{ mA}$, $T_J = 25^\circ\text{C}$		40	60		
		$I_O = 10\text{ mA}$			90		
		$I_O = 50\text{ mA}$, $T_J = 25^\circ\text{C}$		120	150		
				180			
	Peak output current/current limit	$T_J = 25^\circ\text{C}$	100	125		mA	



TPS76030, TPS76032, TPS76033, TPS76038, TPS76050
LOW-POWER 50-mA LOW-DROPOUT LINEAR REGULATORS

SLVS144B –JULY 1998 – REVISED FEBRUARY 1999

**electrical characteristics over recommended operating free-air temperature range,
 $V_I = V_{O(nom)} + 1\text{ V}$, $I_O = 1\text{ mA}$, $EN = V_I$, $C_O = 1\text{ }\mu\text{F}$ (unless otherwise noted) (continued)**

PARAMETER		TEST CONDITIONS	MIN	TYP	MAX	UNIT
	High level enable input		2			V
	Low level enable input				0.8	V
I_I	Input current (EN)	$EN = 0\text{ V}$	-1	0	1	μA
		$EN = V_I$		2.5	5	μA

TYPICAL CHARACTERISTICS

Table of Graphs

			FIGURE
V_O	Output voltage	vs Output current	1, 2, 3
		vs Free-air temperature	4, 5, 6
	Ground current	vs Free-air temperature	7, 8, 9
	Output noise	vs Frequency	10
Z_o	Output impedance	vs Frequency	11
V_{DO}	Dropout voltage	vs Free-air temperature	12
	Line transient response		13, 15
	Load transient response		14, 16



TYPICAL CHARACTERISTICS

TPS76030
 OUTPUT VOLTAGE
 vs
 OUTPUT CURRENT

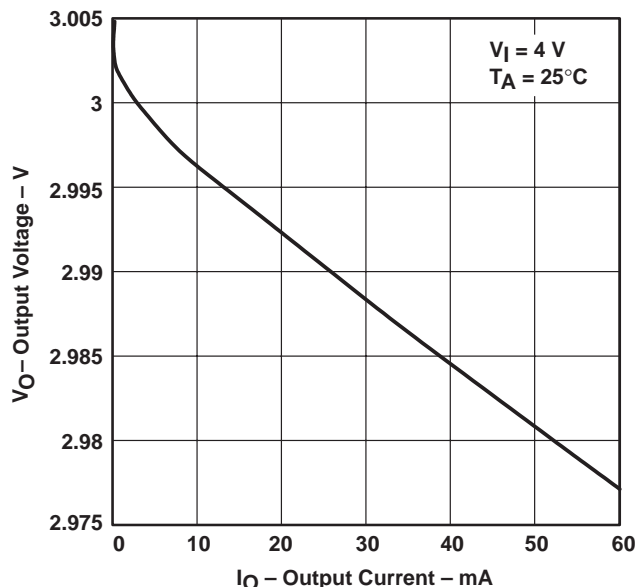

Figure 1

TPS76033
 OUTPUT VOLTAGE
 vs
 OUTPUT CURRENT

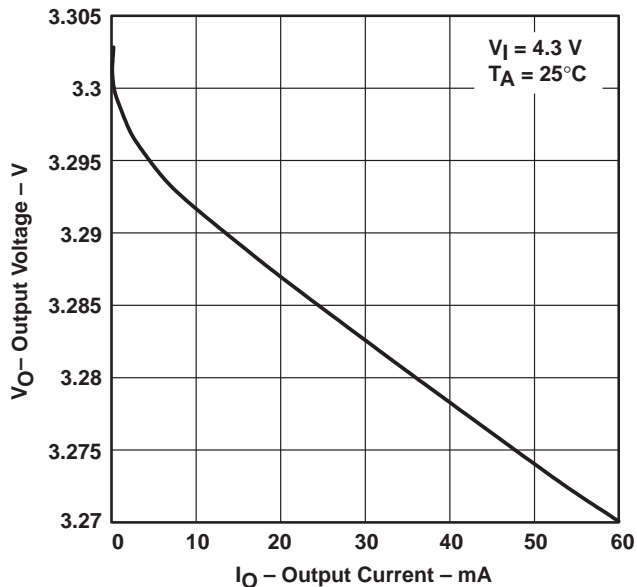

Figure 2

TPS76050
 OUTPUT VOLTAGE
 vs
 OUTPUT CURRENT

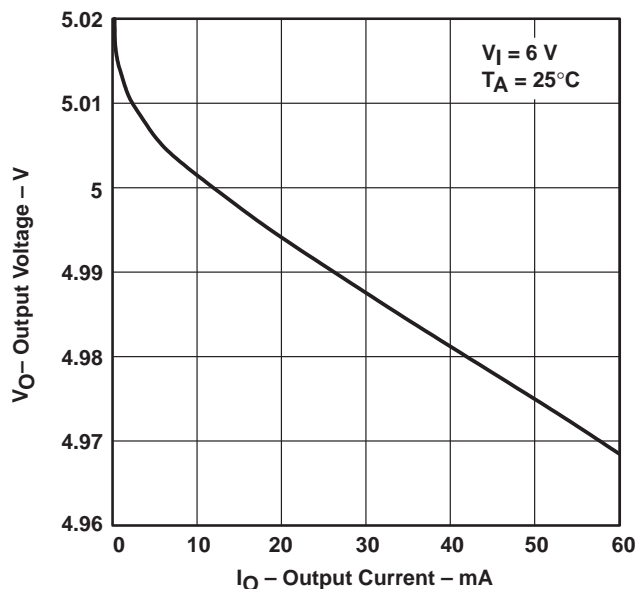

Figure 3

TPS76030
 OUTPUT VOLTAGE
 vs
 FREE-AIR TEMPERATURE

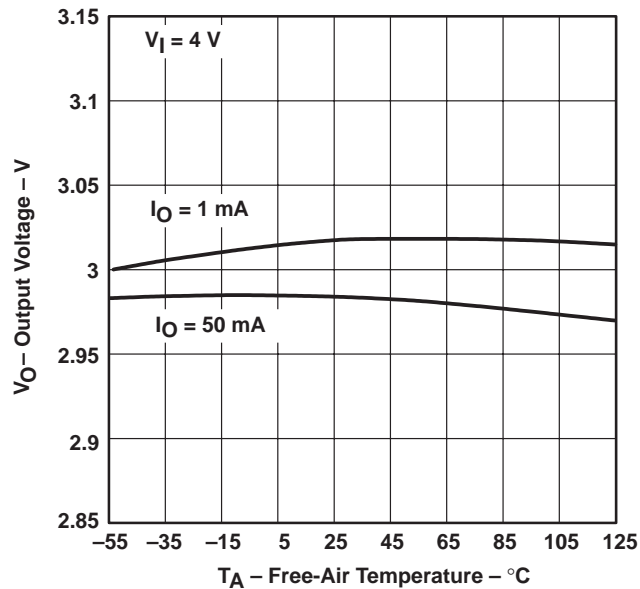

Figure 4

TPS76030, TPS76032, TPS76033, TPS76038, TPS76050

LOW-POWER 50-mA LOW-DROPOUT LINEAR REGULATORS

SLVS144B – JULY 1998 – REVISED FEBRUARY 1999

TYPICAL CHARACTERISTICS

TPS76033
OUTPUT VOLTAGE
vs
FREE-AIR TEMPERATURE

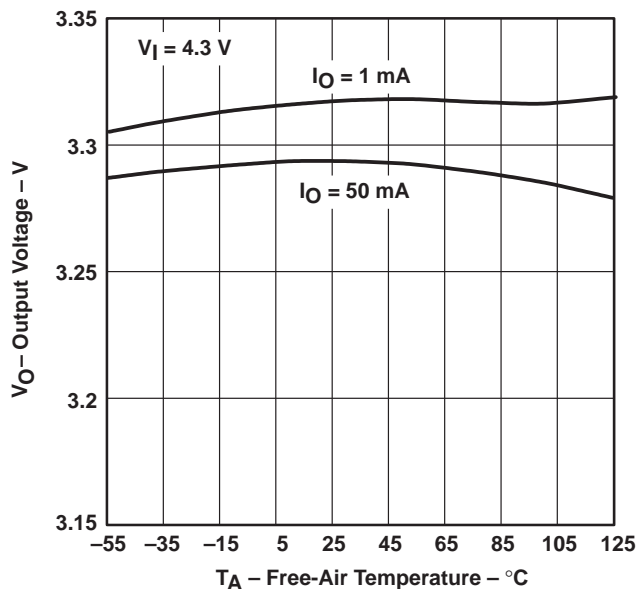

Figure 5

TPS76050
OUTPUT VOLTAGE
vs
FREE-AIR TEMPERATURE

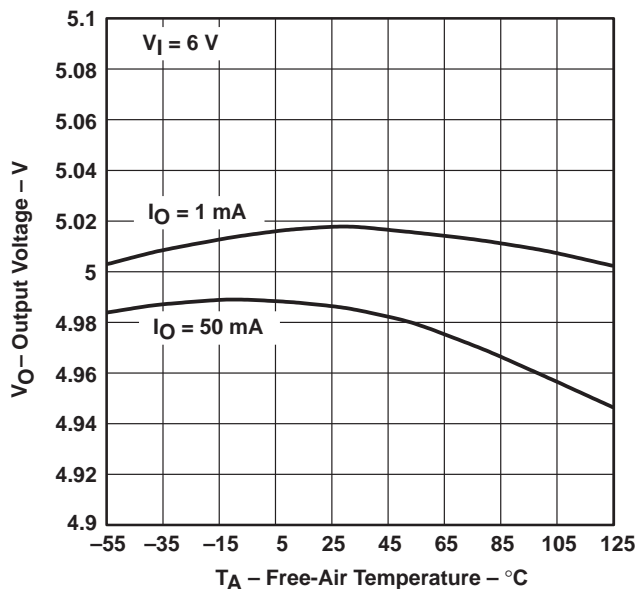

Figure 6

TPS76030
GROUND CURRENT
vs
FREE-AIR TEMPERATURE

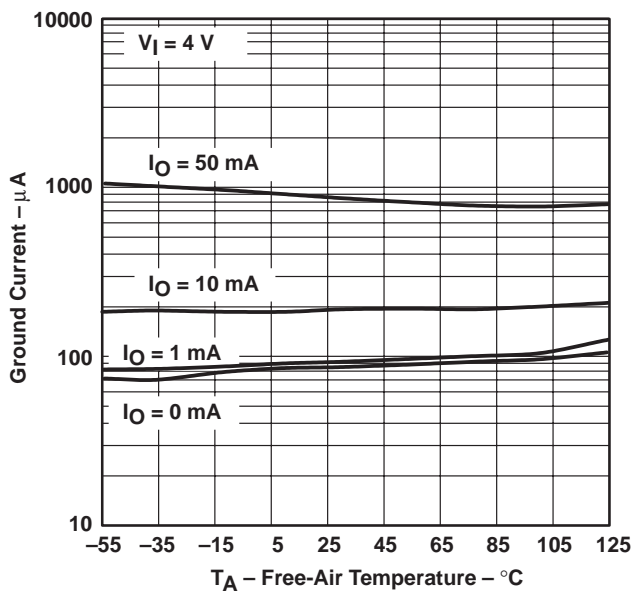

Figure 7

TPS76033
GROUND CURRENT
vs
FREE-AIR TEMPERATURE

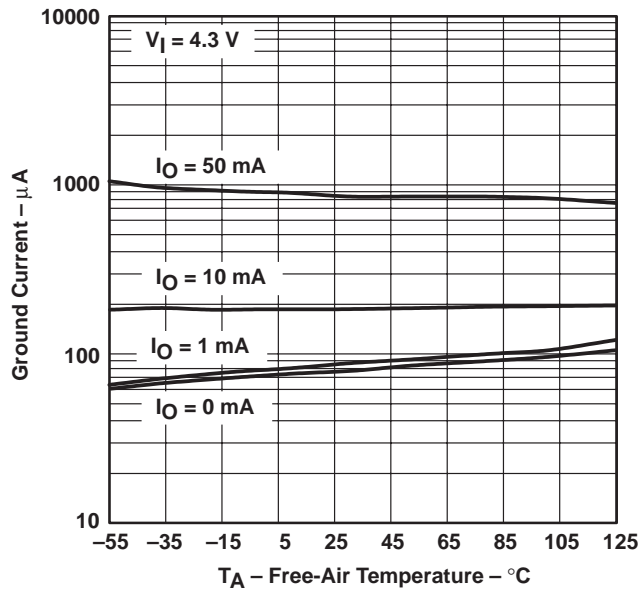
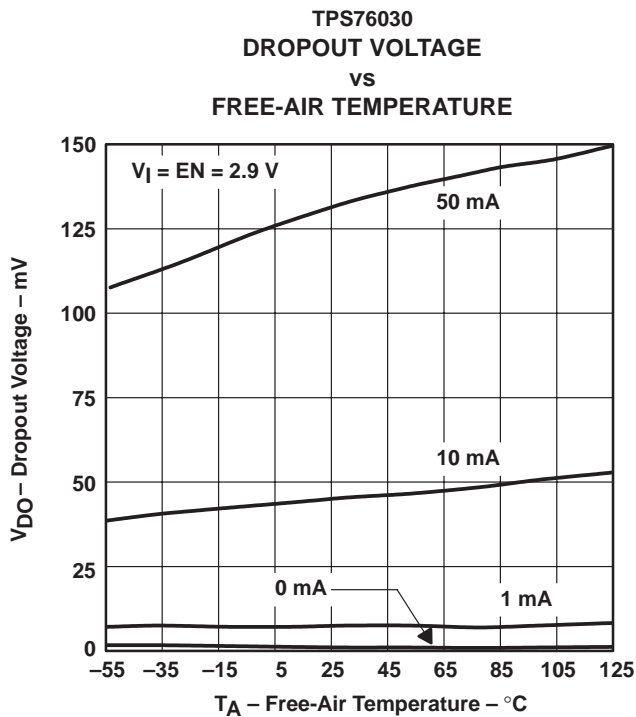
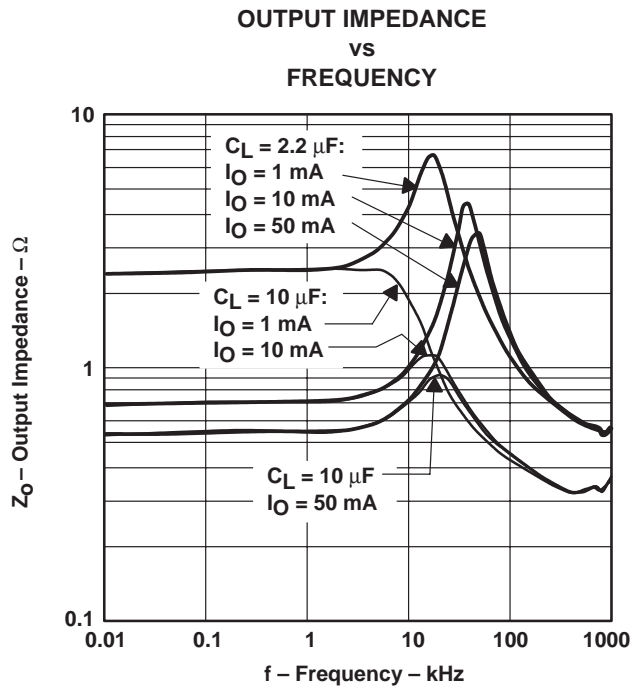
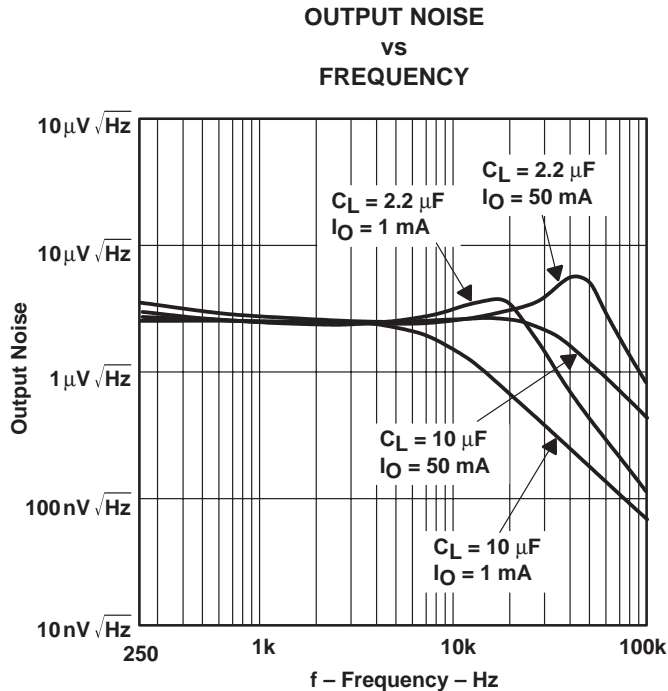
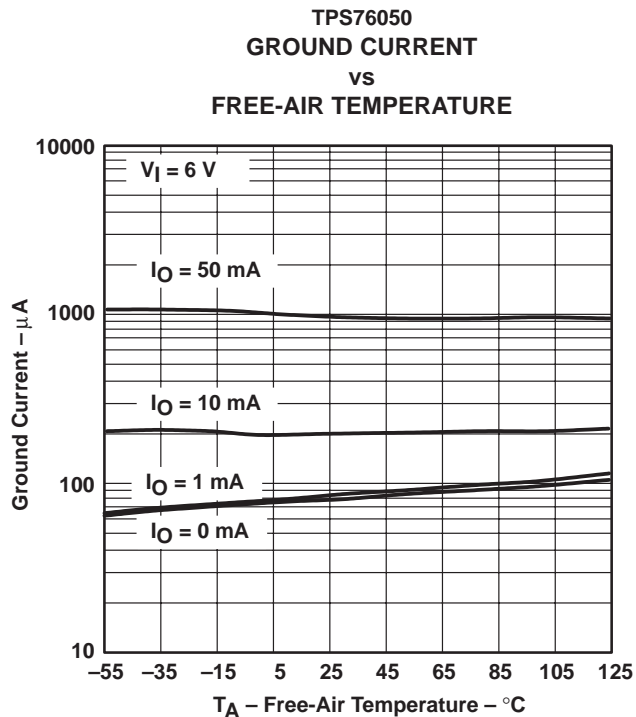

Figure 8



TYPICAL CHARACTERISTICS



TPS76030, TPS76032, TPS76033, TPS76038, TPS76050

LOW-POWER 50-mA LOW-DROPOUT LINEAR REGULATORS

SLVS144B – JULY 1998 – REVISED FEBRUARY 1999

TYPICAL CHARACTERISTICS

TPS76033
LINE TRANSIENT RESPONSE

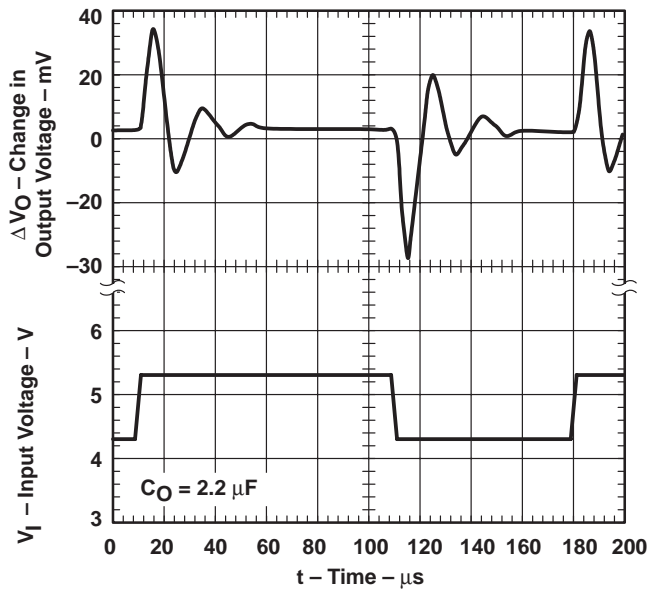

Figure 13

TPS76033
LOAD TRANSIENT RESPONSE

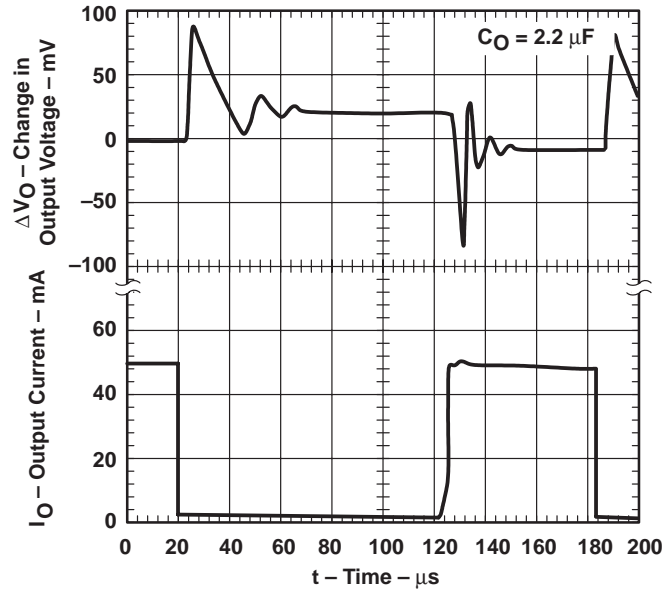

Figure 14

TPS76050
LINE TRANSIENT RESPONSE

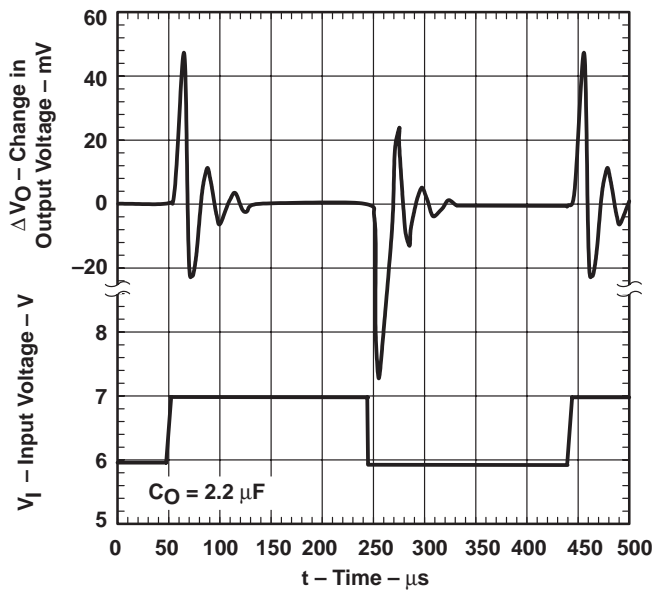

Figure 15

TPS76050
LOAD TRANSIENT RESPONSE

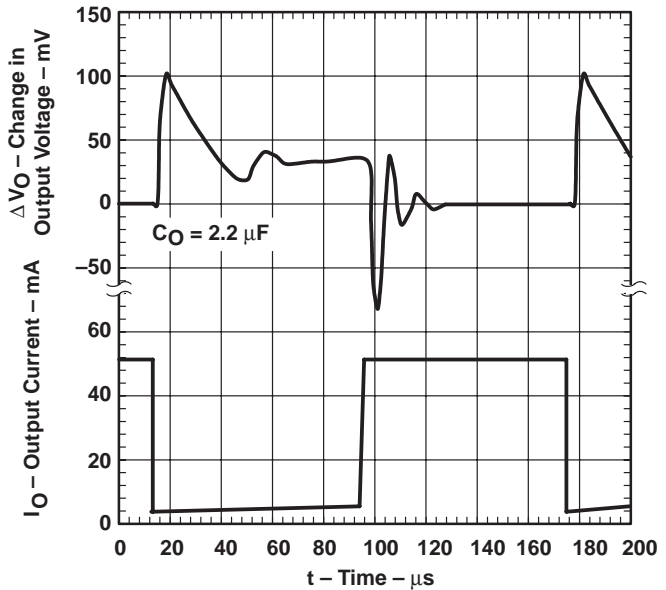

Figure 16



APPLICATION INFORMATION

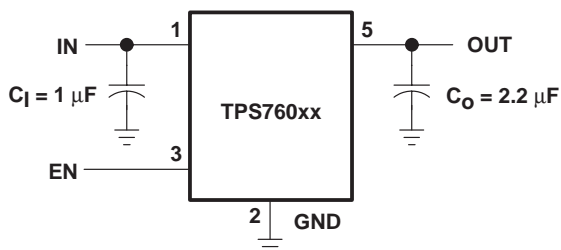

Figure 17. TPS760xx Typical Application

over current protection

The over current protection circuit forces the TPS760xx into a constant current output mode when the load is excessive or the output is shorted to ground. Normal operation resumes when the fault condition is removed. An overload or short circuit may also activate the over temperature protection if the fault condition persists.

over temperature protection

The thermal protection system shuts the TPS760xx down when the junction temperature exceeds 160°C. The device recovers and operates normally when the temperature drops below 150°C.

input capacitor

A 0.047 µF or larger ceramic decoupling capacitor with short leads connected between IN and GND is recommended. The decoupling capacitor may be omitted if there is a 1 µF or larger electrolytic capacitor connected between IN and GND and located reasonably close to the TPS760xx. However, the small ceramic device is desirable even when the larger capacitor is present, if there is a lot of high frequency noise present in the system.

output capacitor

Like all low dropout regulators, the TPS760xx requires an output capacitor connected between OUT and GND to stabilize the internal control loop. The minimum recommended capacitance value is 2.2 µF and the ESR (equivalent series resistance) must be between 0.1 Ω and 20 Ω. Capacitor values of 2.5-µF or larger are acceptable, provided the ESR is less than 20 Ω. Solid tantalum electrolytic, aluminum electrolytic, and multilayer ceramic capacitors are all suitable, provided they meet the requirements described above. Most of the commercially available 2.2-µF surface-mount solid-tantalum capacitors, including devices from Sprague, Kemet, and Nichicon, meet the ESR requirements stated above. Multilayer ceramic capacitors should have minimum values of 2.5 µF over the full operating temperature range of the equipment.

enable (EN)

A logic zero on the enable input shuts the TPS760xx off and reduces the supply current to less than 1 µA. Pulling the enable input high causes normal operation to resume. If the enable feature is not used, EN should be connected to IN to keep the regulator on all of the time. The EN input must not be left floating.

TPS76030, TPS76032, TPS76033, TPS76038, TPS76050 LOW-POWER 50-mA LOW-DROPOUT LINEAR REGULATORS

SLVS144B –JULY 1998 – REVISED FEBRUARY 1999

APPLICATION INFORMATION

reverse current path

The power transistor used in the TPS760xx has an inherent diode connected between IN and OUT as shown in the functional block diagram. This diode conducts current from the OUT terminal to the IN terminal whenever IN is lower than OUT by a diode drop. This condition does not damage the TPS760xx, provided the current is limited to 100mA.

MECHANICAL DATA

DBV (R-PDSO-G5)

PLASTIC SMALL-OUTLINE PACKAGE

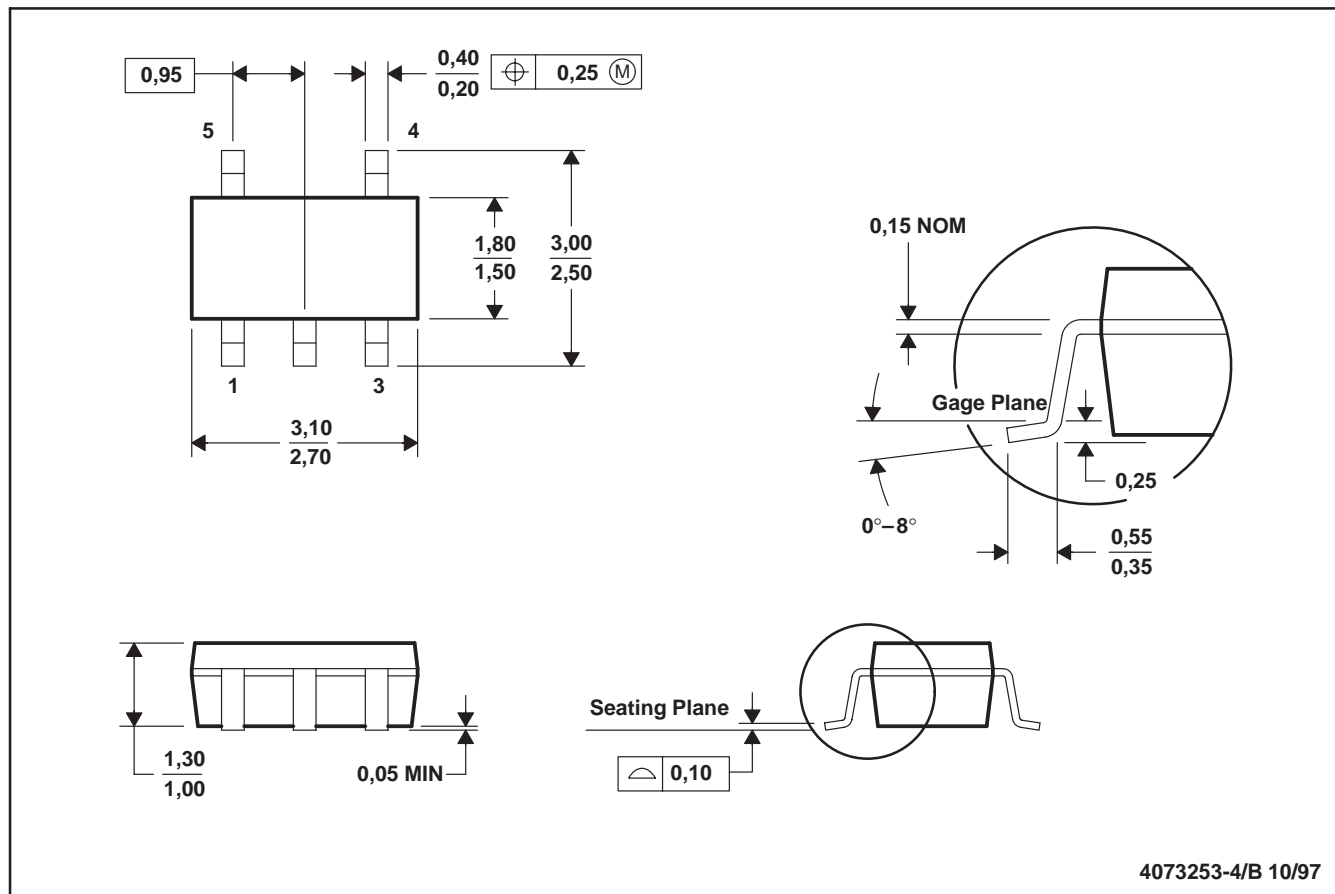

- NOTES: A. All linear dimensions are in millimeters.
 B. This drawing is subject to change without notice.
 C. Body dimensions include mold flash or protrusion.

IMPORTANT NOTICE

Texas Instruments and its subsidiaries (TI) reserve the right to make changes to their products or to discontinue any product or service without notice, and advise customers to obtain the latest version of relevant information to verify, before placing orders, that information being relied on is current and complete. All products are sold subject to the terms and conditions of sale supplied at the time of order acknowledgement, including those pertaining to warranty, patent infringement, and limitation of liability.

TI warrants performance of its semiconductor products to the specifications applicable at the time of sale in accordance with TI's standard warranty. Testing and other quality control techniques are utilized to the extent TI deems necessary to support this warranty. Specific testing of all parameters of each device is not necessarily performed, except those mandated by government requirements.

CERTAIN APPLICATIONS USING SEMICONDUCTOR PRODUCTS MAY INVOLVE POTENTIAL RISKS OF DEATH, PERSONAL INJURY, OR SEVERE PROPERTY OR ENVIRONMENTAL DAMAGE ("CRITICAL APPLICATIONS"). TI SEMICONDUCTOR PRODUCTS ARE NOT DESIGNED, AUTHORIZED, OR WARRANTED TO BE SUITABLE FOR USE IN LIFE-SUPPORT DEVICES OR SYSTEMS OR OTHER CRITICAL APPLICATIONS. INCLUSION OF TI PRODUCTS IN SUCH APPLICATIONS IS UNDERSTOOD TO BE FULLY AT THE CUSTOMER'S RISK.

In order to minimize risks associated with the customer's applications, adequate design and operating safeguards must be provided by the customer to minimize inherent or procedural hazards.

TI assumes no liability for applications assistance or customer product design. TI does not warrant or represent that any license, either express or implied, is granted under any patent right, copyright, mask work right, or other intellectual property right of TI covering or relating to any combination, machine, or process in which such semiconductor products or services might be or are used. TI's publication of information regarding any third party's products or services does not constitute TI's approval, warranty or endorsement thereof.