



### P-Channel 30-V (D-S) MOSFET

#### CHARACTERISTICS

- P-Channel Vertical DMOS
- Macro Model (Subcircuit Model)
- Level 3 MOS
- Apply for both Linear and Switching Application
- Accurate over the -55 to 125°C Temperature Range
- Model the Gate Charge, Transient, and Diode Reverse Recovery Characteristics

#### DESCRIPTION

The attached spice model describes the typical electrical characteristics of the p-channel vertical DMOS. The subcircuit model is extracted and optimized over the -55 to 125°C temperature ranges under the pulsed 0-V to 10-V gate drive. The saturated output impedance is best fit at the gate bias near the threshold voltage.

A novel gate-to-drain feedback capacitance network is used to model the gate charge characteristics while avoiding convergence difficulties of the switched  $C_{gd}$  model. All model parameter values are optimized to provide a best fit to the measured electrical data and are not intended as an exact physical interpretation of the device.

#### SUBCIRCUIT MODEL SCHEMATIC

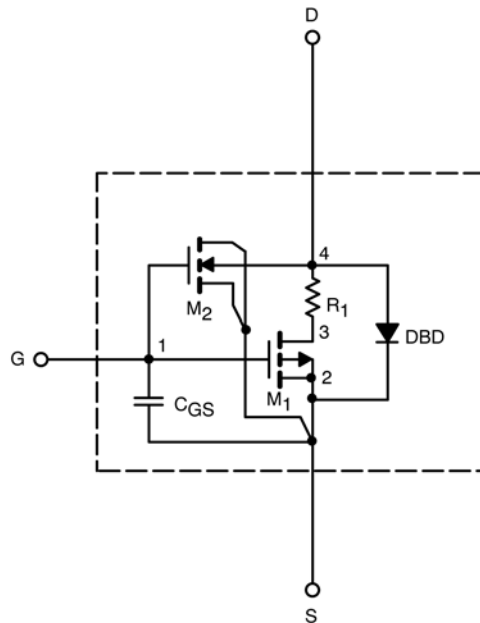

This document is intended as a SPICE modeling guideline and does not constitute a commercial product data sheet. Designers should refer to the appropriate data sheet of the same number for guaranteed specification limits.

# SPICE Device Model Si4435BDY



## Vishay Siliconix

SPECIFICATIONS ( $T_J = 25^\circ\text{C}$ UNLESS OTHERWISE NOTED)					
Parameter	Symbol	Test Condition	Simulated Data	Measured Data	Unit
<b>Static</b>					
Gate Threshold Voltage	$V_{GS(th)}$	$V_{DS} = V_{GS}, I_D = -250 \mu\text{A}$	1.9		V
On-State Drain Current <sup>a</sup>	$I_{D(on)}$	$V_{DS} = -5 \text{ V}, V_{GS} = -10 \text{ V}$	309		A
Drain-Source On-State Resistance <sup>a</sup>	$r_{DS(on)}$	$V_{GS} = -10 \text{ V}, I_D = -9.1 \text{ A}$	0.015	0.015	$\Omega$
		$V_{GS} = -4.5 \text{ V}, I_D = -6.9 \text{ A}$	0.025	0.025	
Forward Transconductance <sup>a</sup>	$g_{fs}$	$V_{DS} = -10 \text{ V}, I_D = -9.1 \text{ A}$	22	24	S
Diode Forward Voltage <sup>a</sup>	$V_{SD}$	$I_S = -2.1 \text{ A}, V_{GS} = 0 \text{ V}$	-0.81	-0.80	V
<b>Dynamic<sup>b</sup></b>					
Total Gate Charge	$Q_g$	$V_{DS} = -15 \text{ V}, V_{GS} = -10 \text{ V}, I_D = -9.1 \text{ A}$	32	33	nC
Gate-Source Charge	$Q_{gs}$		5.8	5.8	
Gate-Drain Charge	$Q_{gd}$		8.6	8.6	
Turn-On Delay Time	$t_{d(on)}$	$V_{DD} = -15 \text{ V}, R_L = 15 \Omega$ $I_D \cong -1 \text{ A}, V_{GEN} = -10 \text{ V}, R_G = 6 \Omega$	19	10	ns
Rise Time	$t_r$		14	15	
Turn-Off Delay Time	$t_{d(off)}$		184	110	
Fall Time	$t_f$		35	70	
Source-Drain Reverse Recovery Time	$t_{rr}$	$I_F = -2.1 \text{ A}, di/dt = 100 \text{ A}/\mu\text{s}$	55	60	

### Notes

- a. Pulse test; pulse width  $\leq 300 \mu\text{s}$ , duty cycle  $\leq 2\%$ .
- b. Guaranteed by design, not subject to production testing.



# SPICE Device Model Si4435BDY

## Vishay Siliconix

COMPARISON OF MODEL WITH MEASURED DATA ( $T_J=25^\circ\text{C}$  UNLESS OTHERWISE NOTED)

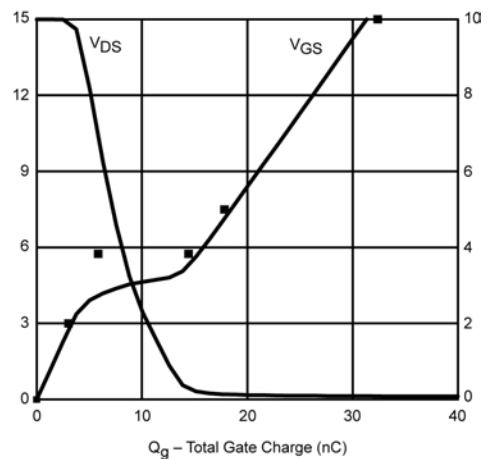
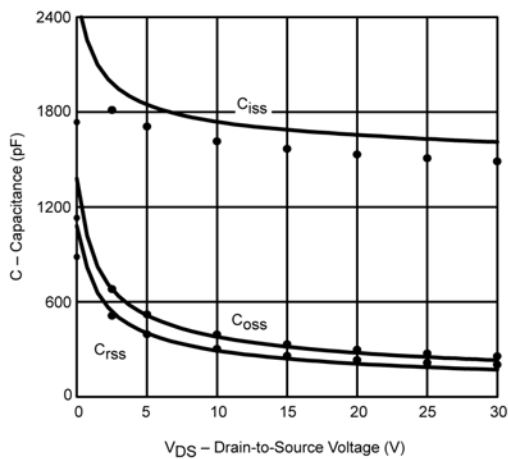
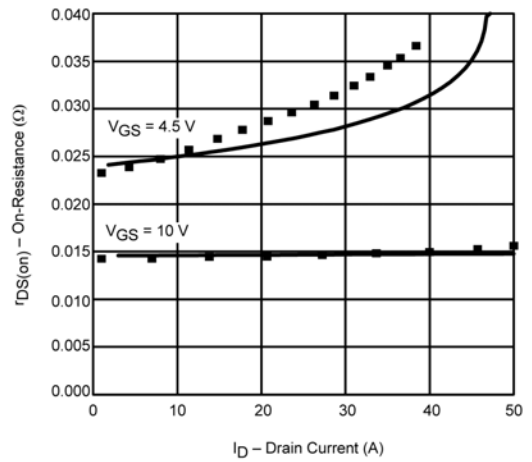
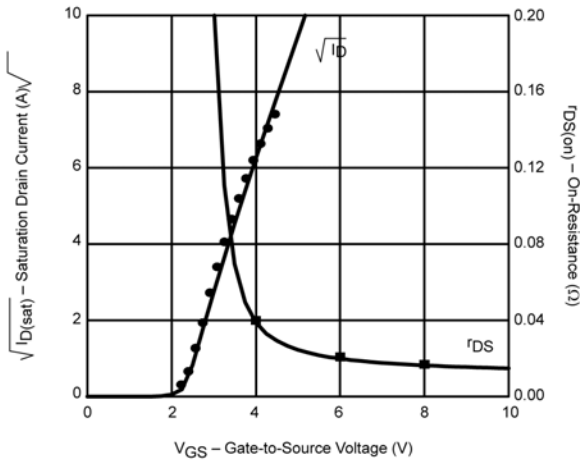
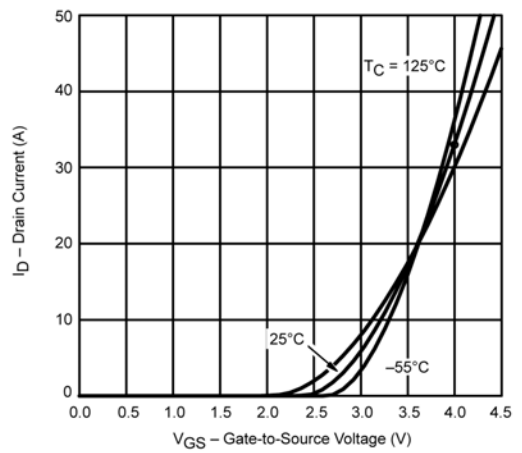
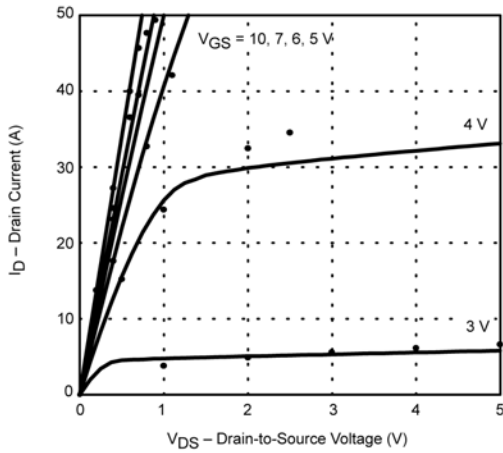

Note: Dots and squares represent measured data.