

### SPECIFICATIONS

<b>CUSTOMER</b>	:	CDE016
<b>SAMPLE CODE (Ver.)</b>	:	PS320240WRF-DBAH01 (Ver.0)
<b>MASS PRODUCTION CODE (Ver.)</b>	:	PG320240WRFDDBAHYZQ
<b>DRAWING NO. (Ver.)</b>	:	PG-03100-164 (Ver.0)

**Customer Approved**

**Date:**

Approved	QC Confirmed	Designer
		

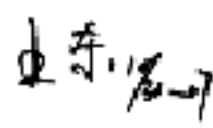
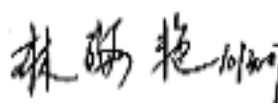
- Approval For Specifications Only.
- \* This specification is subject to change without notice.
- Please contact Powertip or it's representative before designing your product based on this specification.
- Approval For Specifications and Sample.

### POWERTIP TECH. CORP.

**Headquarters:**

No.8, 6 <sup>th</sup> Road, Taichung Industrial Park,	TEL: 886-4-2355-8168	E-mail: <a href="mailto:sales@powertip.com.tw">sales@powertip.com.tw</a>
Taichung, Taiwan	FAX: 886-4-2355-8166	<a href="http://www.powertip.com.tw">Http://www.powertip.com.tw</a>
台中市 407 工業區六路 8 號		

**RECORDS OF REVISION**

Date	Rev.	Description	Note	Page
2006/07/19	0	Mass production JF,JDS-1,JE1,JE2,JMS-2,JP-2,JA1 Short	-	-
2007/10/9	A	Update PACKING SPECIFICATION		21

Total : 22Page

## Contents

### 1. SPECIFICATIONS

- 1.1 Features
- 1.2 Mechanical Specifications
- 1.3 Absolute Maximum Ratings
- 1.4 DC Electrical Characteristics
- 1.5 Optical Characteristics
- 1.6 Backlight Characteristics

### 2. MODULE STRUCTURE

- 2.1 Counter Drawing
- 2.2 Interface Pin Description
- 2.3 Timing Characteristics

### 3. QUALITY ASSURANCE SYSTEM

- 3.1 Quality Assurance Flow Chart
- 3.2 Inspection Specification

### 4. RELIABILITY TEST

- 4.1 Reliability Test Condition

### 5. PRECAUTION RELATING PRODUCT HANDLING

- 5.1 Safety
- 5.2 Handling
- 5.3 Storage
- 5.4 Terms of Warranty

### 6. PACKING SPECIFICATION

- Appendix: 1. LCM Drawing
- 2. Package

Note : For detailed information please refer to IC data sheet : RAIO RA8835P3N

## 1. SPECIFICATIONS

### 1.1 Features

Item	Standard Value
Display Type	320 * 240 Dots
LCD Type	FSTN, Positive , Transflective
Driver Condition	LCD Module: 1/240 Duty, 1/16 Bias
Viewing Direction	6 O'clock
Backlight	LED B/L
Weight	280 g
Interface	8080 series and 8 bit parallel data input
ROHS	THIS PRODUCT CONFORMS THE ROHS OF PTC Detail information please refer web side : <a href="http://www.powertip.com.tw/news/LatestNews.asp">http://www.powertip.com.tw/news/LatestNews.asp</a>

### 1.2 Mechanical Specifications

Item	Standard Value	Unit
Outline Dimension	153.54 (L) * 120.24 (w) * 21.0 (H)(Max)	mm
Viewing Area	120.14 (L) * 92.14 (w)	mm
Active Area	115.17 (L) * 86.37 (w)	mm
Dot Size	0.33 (L) * 0.33 (w)	mm
Dot Pitch	0.36 (L) * 0.36 (w)	mm

Note : For detailed information please refer to LCM drawing

### 1.3 Absolute Maximum Ratings

Item	Symbol	Condition	Min.	Max.	Unit
Power Supply Voltage	$V_{DD}$	—	-0.3	+7.0	V
LCD Driver Supply Voltage	$V_{DD}-V_{EE}$	-	-0.3	32	V
Input Voltage	$V_{IN}$	—	-0.3	$V_{DD}+0.3$	V
Operating Temperature	$T_{OP}$	—	-20	70	°C
Storage Temperature.	$T_{ST}$	—	-30	80	°C
Storage Humidity	$H_D$	$T_a < 40\text{ °C}$	20	90	%RH

## 1.4 DC Electrical Characteristics

$V_{DD} = 5 \pm 0.5V$ ,  $V_{SS} = 0V$ ,  $T_a = 25^\circ C$

Item	Symbol	Condition	Min.	Typ.	Max.	Unit
Logic Supply Voltage	$V_{DD}$	—	4.5	5	5.5	V
“H” Input Voltage	$V_{IH}$	—	$0.5 V_{DD}$	-	$V_{DD}$	V
“L” Input Voltage	$V_{IL}$	—	$V_{SS}$	-	$0.2V_{DD}$	V
“H” Output Voltage	$V_{OH}$	—	2.4	-	-	V
“L” Output Voltage	$V_{OL}$	—	-	-	$V_{SS} + 0.4$	V
Supply current	$I_{DD}$	$V_{DD} = 5.0 V$	-	-	90	mA
LCM driving voltage	$V_{OP}$ ( $V_{OP+} \sim V_{OP-}$ )	-20°C	-	-	-	V
		25°C	22	22.2	22.4	
		70°C	-	-	-	

## 1.5 Optical Characteristics

LCD Panel: 1/240 Duty, 1/15 Bias,  $V_{LCD} = 22.0 V$ ,  $T_a = 25^\circ C$

Item	Symbol	Conditions	Min.	Typ.	Max.	Reference
View Angle	$\theta$	$C \geq 2.0$ , $\varnothing = 270^\circ$	-40°	-	40°	Notes 1
Contrast Ratio	C	$\theta = -5^\circ$ , $\varnothing = 270^\circ$	2	3	-	Note 3
Response Time(rise)	tr	$\theta = -5^\circ$ , $\varnothing = 270^\circ$	-	120 ms	180 ms	Note 2
Response Time(fall)	tf	$\theta = -5^\circ$ , $\varnothing = 270^\circ$	-	290 ms	435 ms	

Note 1.

Optical characteristics-2

Viewing angle

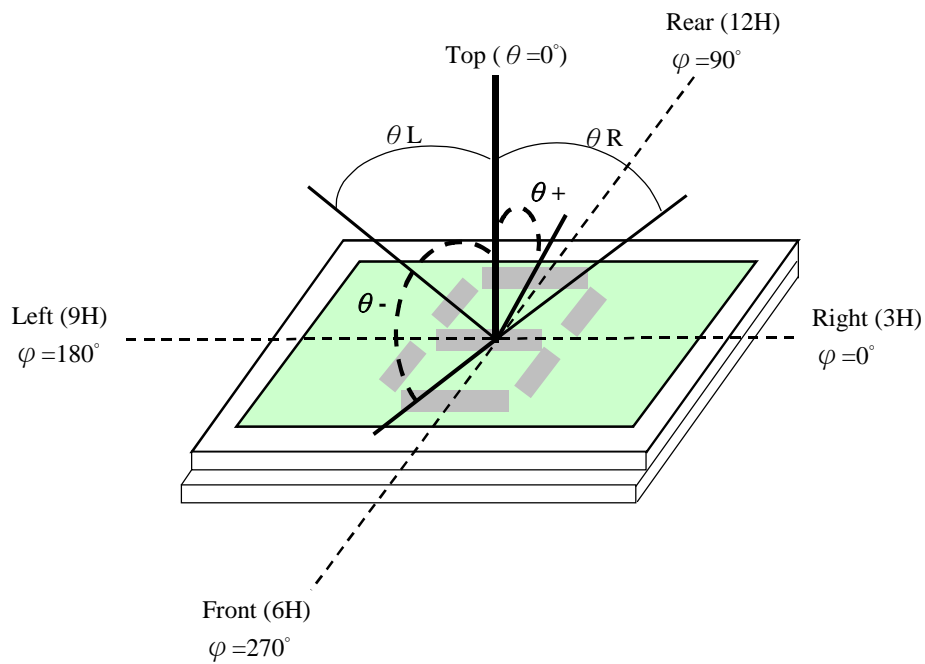

Viewing angle

Note 2.

Optical characteristics-3

Fig.2 Definition of response time

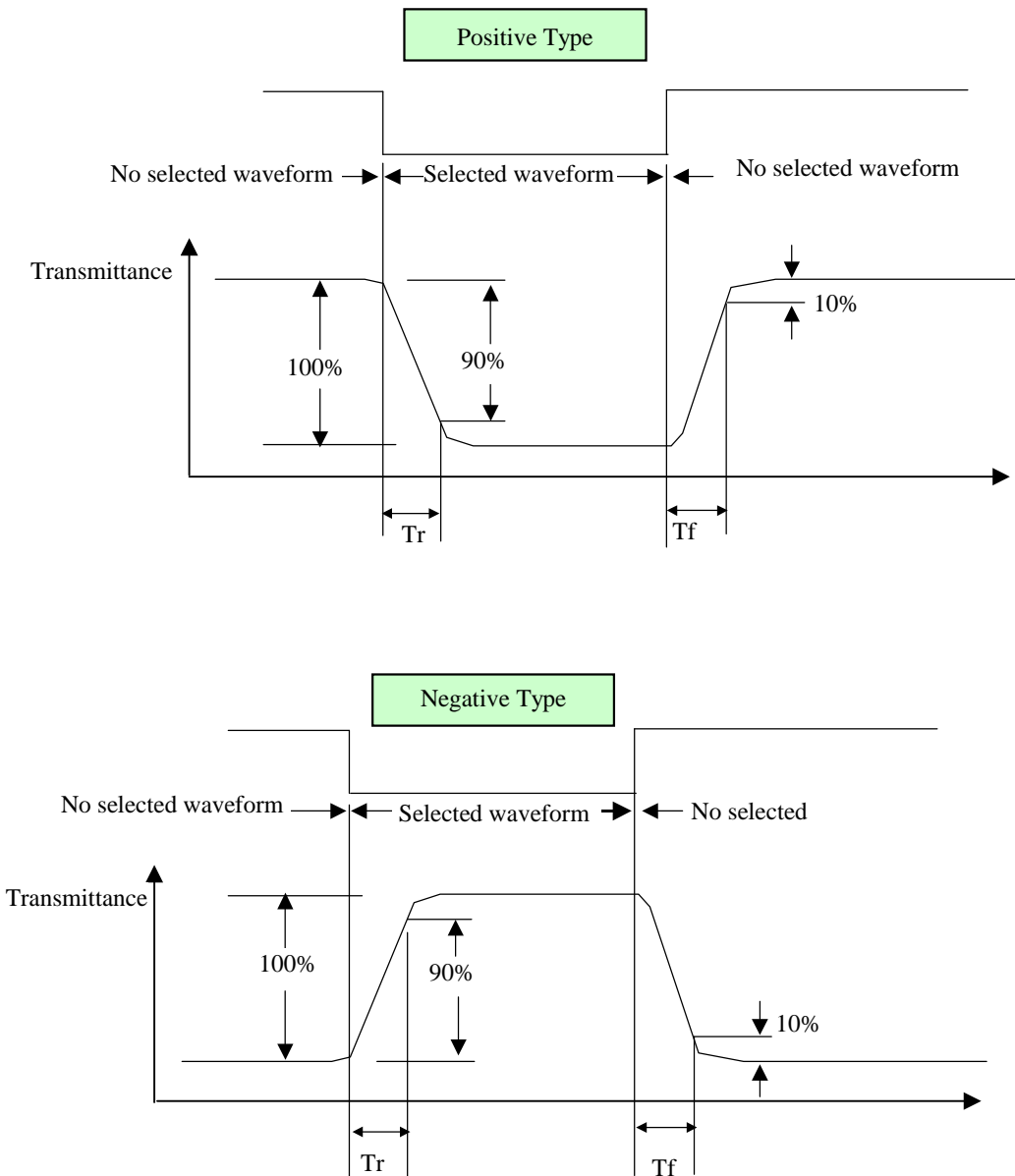

## Electrical characteristics-2

※2 Drive waveform

Vop: Drive voltage

fF: Frame frequency

1/B: Bias

fD: Drive frequency

N: Duty

### (1) Selected waveform

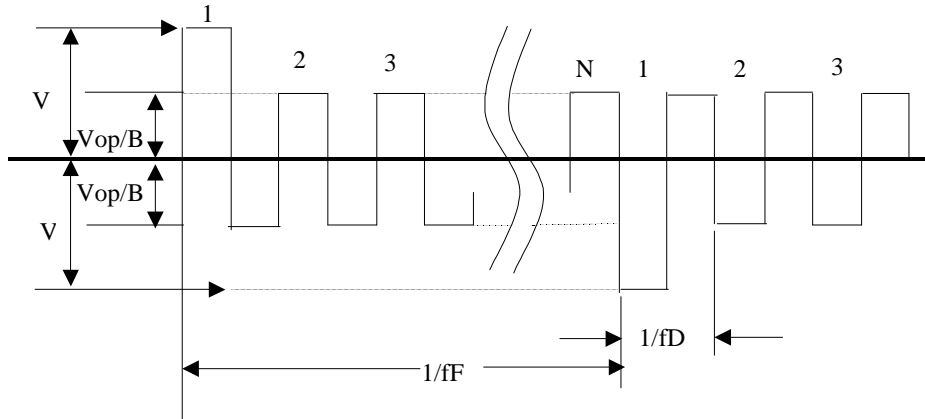

### (2) Non- Selected waveform

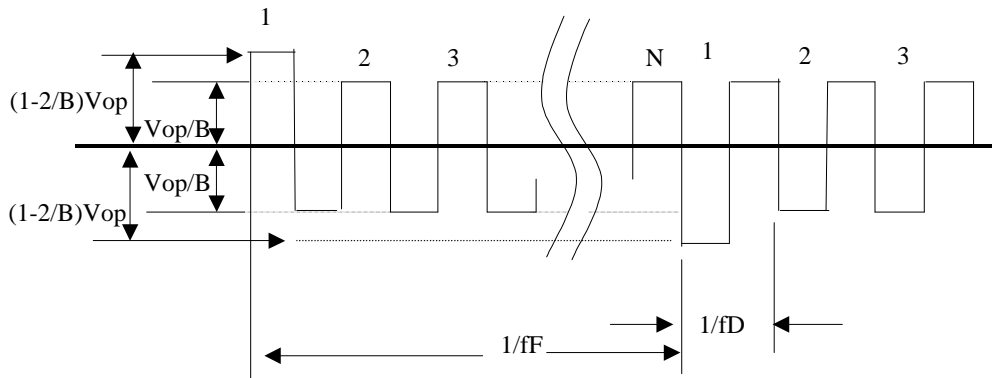

Note:

Frame frequency is defined as follows: Common side supply voltage peak - to - peak / 2 = 1 period



Note 3. : Definition of Vth

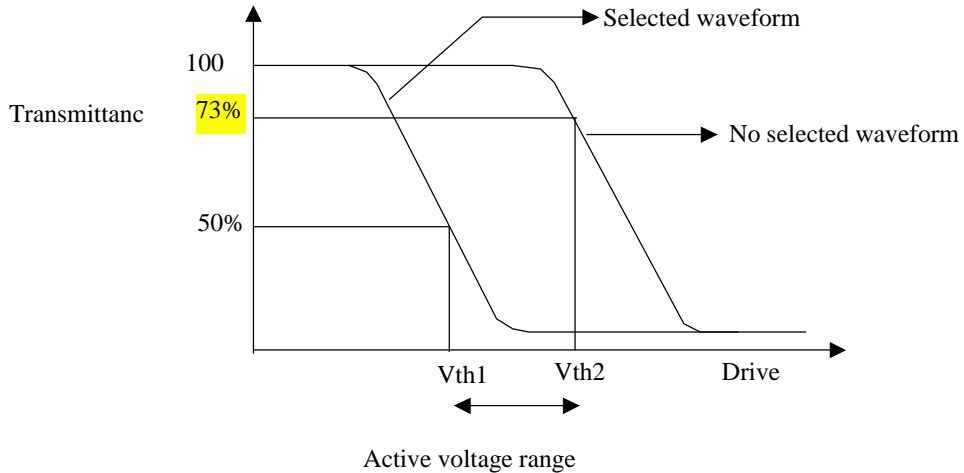

	Vth1	Vth2
View direction	10°	40°
Drive waveform	(Selected waveform)	(No selected waveform)
Transmittance	50%	73%

※1 Contrast ratio  
 = (Brightness in OFF state) / (Brightness in ON state)

Outline of Electro-Optical Characteristics Measuring System

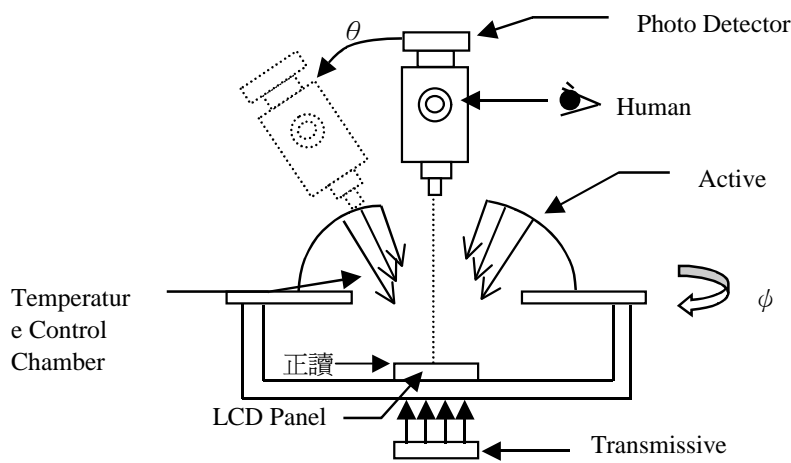

Measuring System: Autronic DMS-803

## 1.6 Backlight Characteristics

LCD Module with LED Backlight

Maximum Ratings

Item	Symbol	Conditions	Min.	Max.	Unit
Forward Current	$I_F$	$T_a = 25^\circ\text{C}$	-	160	mA
Reverse Voltage	$V_R$	$T_a = 25^\circ\text{C}$	-	5	V
Power Dissipation	$P_D$	$T_a = 25^\circ\text{C}$	-	0.67	W

Electrical / Optical Characteristics

Item	Symbol	Conditions	Min.	Typ.	Max.	Unit
Forward Voltage	$V_F$	$I_F = 160\text{ mA}$	-	3.7	4.2	V
Reverse Current	$I_R$	$V_R = 5\text{ V}$	-	-	10	$\mu\text{A}$
Average Brightness (with LCD)	$I_V$	$I_F = 160\text{ mA}$	20	35	-	$\text{cd/m}^2$
CIE Color Coordinate (With LCD)	X	$I_F = 160\text{ mA}$	0.25	0.31	0.37	-
	Y		0.28	0.34	0.40	
Backlight Uniformity (with LCD)	$\Delta B$	$I_F = 160\text{ mA}$	70	-	-	%
Color	White					

Note:  $\Delta B = (\text{Min}/\text{Max})100\%$

## 2. MODULE STRUCTURE

### 2.1 Counter Drawing

#### 2.1.1 LCM Mechanical Diagram

\* See Appendix

#### 2.1.2 Block Diagram

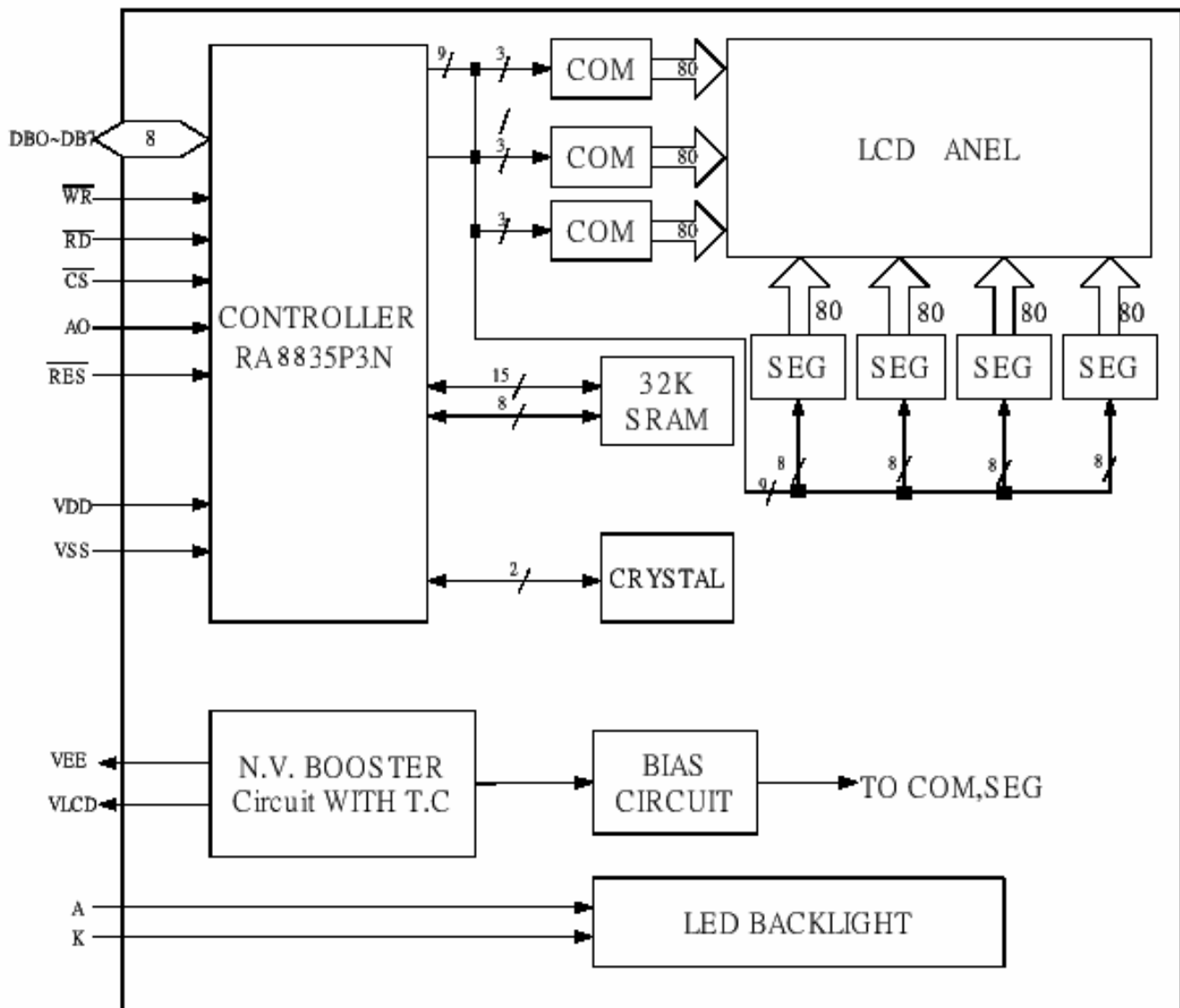

## 2.2 Interface Pin Description

Pin No.	Symbol	Function
1	V <sub>SS</sub>	Ground (V <sub>SS</sub> =0 V)
2	V <sub>DD</sub>	Power Supply (V <sub>DD</sub> = 5.0 V)
3	V <sub>LCD</sub>	Operating voltage for LCD .
4	/RD	Data read (read data from the module at "L")
5	/WR	Data write (write data to the module at "L")
6	A0	Command / Data read or write select (H : command L : data)
7	DB0	Data bus bit 0
8	DB1	Data bus bit 1
9	DB2	Data bus bit 2
10	DB3	Data bus bit 3
11	DB4	Data bus bit 4
12	DB5	Data bus bit 5
13	DB6	Data bus bit 6
14	DB7	Data bus bit 7
15	/CS	Chip select , active "L"
16	/RES	Reset input , active "L"
17	V <sub>EE</sub>	Negative voltage out .
18	FG	Frame ground (connected to metal bezel)
19	NC	Not connection
20	NC	Not connection
-	A	Power supply for LED backlight Anode input
-	K	Power supply for LED backlight cathode input

Built in negative voltage generator circuit and temperature compensation circuit.

Built in Timing mode for 8080 family.

## 2.3 Timing Characteristics

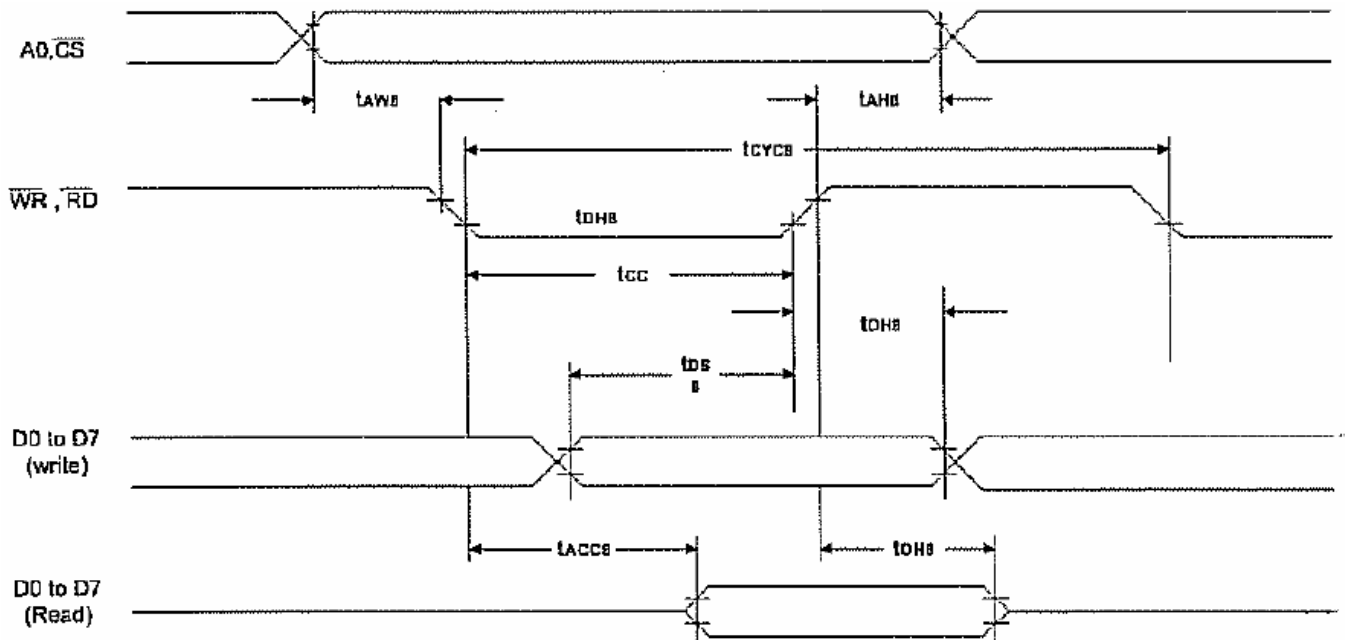

$T_a = -20$  to  $75^\circ\text{C}$

Signal	Symbol	Parameter	$V_{DD} = 4.5$ to $5.5\text{V}$		$V_{DD} = 2.7$ to $4.5\text{V}$		Unit	Condition
			Min.	Max.	Min.	Max.		
A0, $\overline{\text{CS}}$	$t_{AHB}$	Address hold time	10	—	10	—	ns	CL = 100pF
	$t_{AWB}$	Address setup time	0	—	0	—	ns	
$\overline{\text{WR}}$ , $\overline{\text{RD}}$	$t_{CYCB}$	System cycle time	note.	—	note.	—	ns	
	$t_{CC}$	Strobe pulse width	120	—	150	—	ns	
D0 to D7	$t_{DSB}$	Data setup time	120	—	120	—	ns	
	$t_{DHB}$	Data hold time	5	—	5	—	ns	
	$t_{ACCB}$	$\overline{\text{RD}}$ access time	—	50	—	80	ns	
	$t_{OHB}$	Output disable time	10	50	10	55	ns	

**Note:** For memory control and system control commands:

$$t_{CYCB} = 2t_c + t_{CC} + t_{CEA} + 75 > t_{ACV} + 245$$

For all other commands:

$$t_{CYCB} = 4t_c + t_{CC} + 30$$

## 2.4 Display Command

Class	Command	Code												Hex	Command description
		RD	WR	A0	D7	D6	D5	D4	D3	D2	D1	D0			
System control	SYSTEM SET	1	0	1	0	1	0	0	0	0	0	0	0	40	Initialize device and display
	SLEEP IN	1	0	1	0	1	0	1	0	0	1	1	53	Enter standby mode	
Display control	DISP ON/OFF	1	0	1	0	1	0	1	1	0	0	D	58.59	Enable and disable display and display flashing	
	SCROLL	1	0	1	0	1	0	0	0	1	0	0	44	Set display start address and display regions	
	CSRFORM	1	0	1	0	1	0	1	1	1	0	1	5D	Set cursor type	
	CGRAM ADR	1	0	1	0	1	0	1	1	1	0	0	5C	Set start address of character generator RAM	
	CSRDIR	1	0	1	0	1	0	0	1	1	CD 1	CD 0	4C to 4F	Set direction of cursor movement	
	HDOT SCR	1	0	1	0	1	0	1	1	0	1	0	5A	Set horizontal scroll position	
	OVLAY	1	0	1	0	1	0	1	1	0	1	1	5B	Set display overlay format	
	GRAY SCALE	1	0	1	0	1	1	0	0	0	0	0	40	Setup grayscale display mode	
Drawing control	CSRW	1	0	1	0	1	0	0	0	1	1	0	46	Set cursor address	
	CSRR	1	0	1	0	1	0	0	0	1	1	1	47	Read cursor address	
Memory control	MWRITE	1	0	1	0	1	0	0	0	0	1	0	42	Write to display memory	
	MRAD	1	0	1	0	1	0	0	0	0	1	1	43	Read from display memory	

### Notes

- In general, the internal registers of the SED 13700 series are modified as each command parameter is input. However, the microprocessor does not have to set all the parameters of a command and may send a new input will have been changed but the remaining parameter registers are unchanged.
  - 2-byte parameters (where two bytes are treated as 1 data item) are handled as follows:
    - CSRW, CSRR: Each byte is processed individually. The microprocessor may read or write just the low byte of the cursor address.
    - SYSTEM SET, SCROLL, CGRAM ADR: Both parameter bytes are processed together. If the command is changed after half of the parameter has been input, the single byte is ignored.
- APL and APH are 2-byte parameters, but are treated as two 1-byte parameters.

### 3. QUALITY ASSURANCE SYSTEM

#### 3.1 Quality Assurance Flow Chart

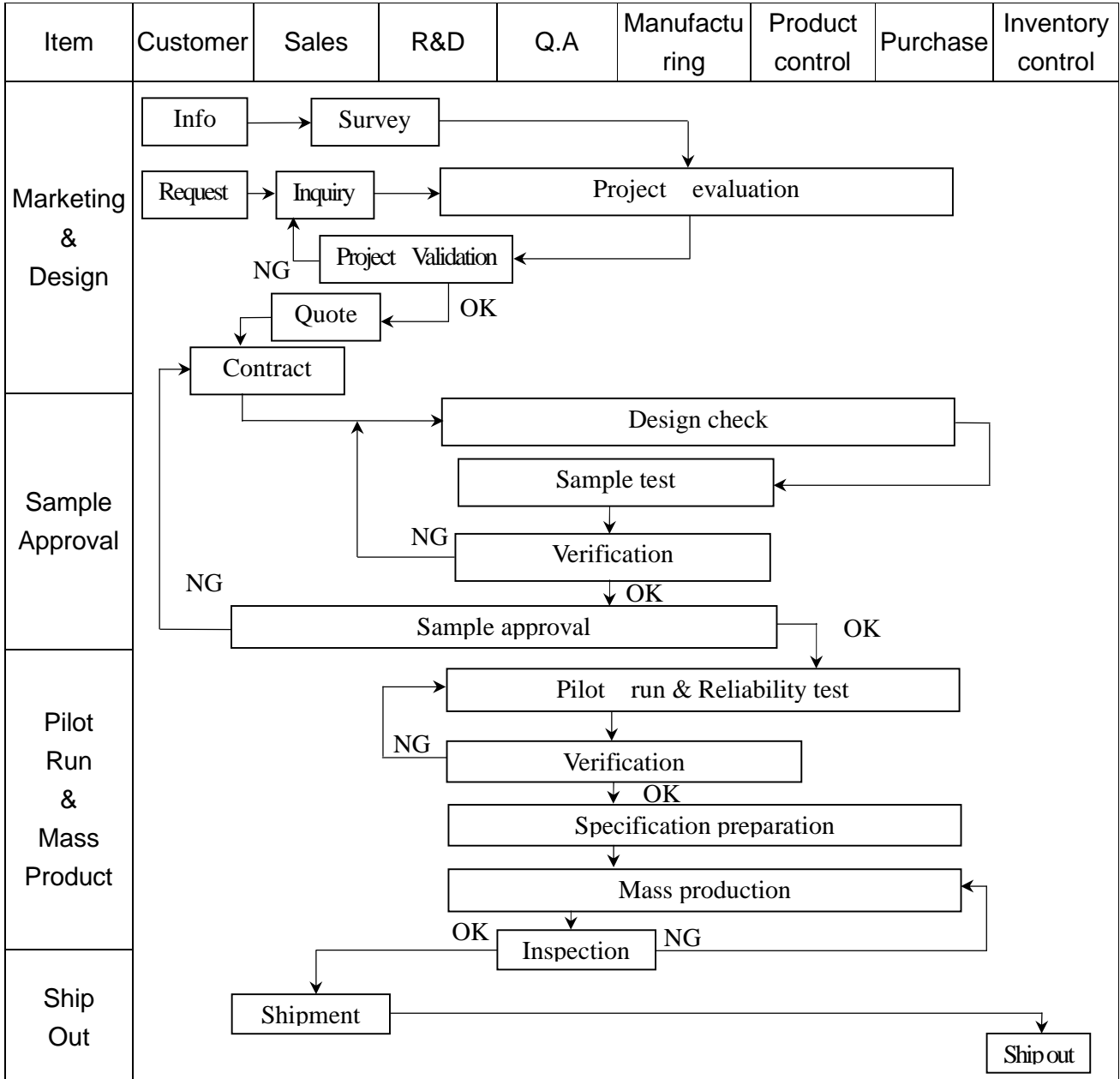

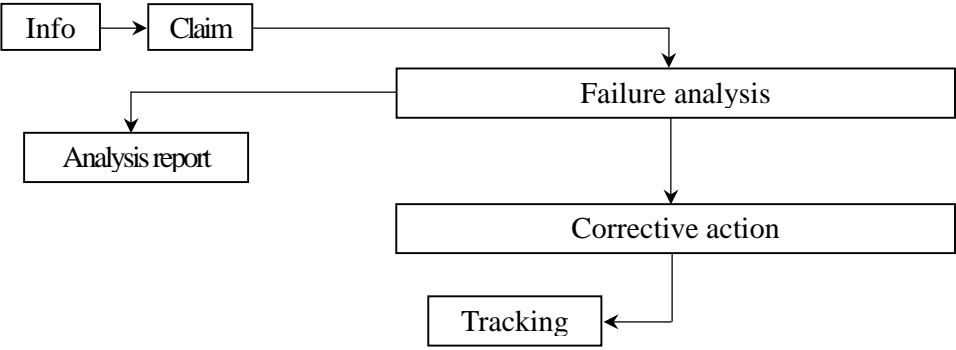
Item	Customer	Sales	R&D	Q.A	Manufacturing	Product control	Purchase	Inventory control
Sales Service	 <pre> graph TD     Info[Info] --&gt; Claim[Claim]     Claim --&gt; FA[Failure analysis]     Claim --&gt; AR[Analysis report]     FA --&gt; CA[Corrective action]     CA --&gt; Tracking[Tracking]           </pre>							
Q.A Activity	1. ISO 9001 Maintenance Activities 3. Equipment calibration 5. Standardization Management				2. Process improvement proposal 4. Education And Training Activities			



### 3.2 Inspection Specification

Inspection Standard : MIL-STD-105E Table Normal Inspection Single Sampling Level II ◦

Equipment : Gauge 、MIL-STD 、Powertip Tester 、Sample ◦

IQC Defect Level : Major Defect AQL 0.4; Minor Defect AQL 1.5 ◦

FQC Defect Level : 100% Inspection ◦

OUT Going Defect Level : Sampling ◦

Specification :

NO	Item	Specification	Judge	Level
1	Part Number	The part number is inconsistent with work order of production	N.G.	Major
2	Quantity	The quantity is inconsistent with work order of production	N.G.	Major
3	Electronic characteristics of LCM $A=(L+W) \div 2$	The display lacks of some patterns.	N.G.	Major
		Missing line.	N.G.	Major
		The size of missing dot, A is $> 1/2$ Dot size	N.G.	Major
		There is no function.	N.G.	Major
		Output data is error	N.G.	Major
4	Appearance of LCD $A=(L+W) \div 2$	Material is different with work order of production	N.G.	Major
		LCD is assembled in inverse direction	N.G.	Major
		Bezel is assembled in inverse direction	N.G.	Major
		Shadow is within LCD viewing area + 0.5 mm	N.G.	Major
		The diameter of dirty particle, A is $> 0.4$ mm	N.G.	Minor
	Dirty particle (Including scratch 、bubble )	Dirty particle length is $> 3.0$ mm, and $0.01$ mm $<$ width $\leq 0.05$ mm	N.G.	Minor
		Display is without protective film	N.G.	Minor
		Conductive rubber is over bezel 1mm	N.G.	Minor
		Polarizer exceeds over viewing area of LCD	N.G.	Minor
		Area of bubble in polarizer, A $> 1.0$ mm, the number of bubble is $> 1$ piece.	N.G.	Minor
		$0.4$ mm $<$ Area of bubble in polarizer, A $< 1.0$ mm, the number of bubble is $> 4$ pieces.	N.G.	Minor
5	Appearance of PCB $A=(L+W) \div 2$	Burned area or wrong part number is on PCB	N.G.	Major
		The symbol, character, and mark of PCB are unidentifiable.	N.G.	Minor
		The stripped solder mask , A is $> 1.0$ mm	N.G.	Minor
		$0.3$ mm $<$ stripped solder mask or visible circuit, A $< 1.0$ mm, and the number is $\geq 4$ pieces	N.G.	Minor
		There is particle between the circuits in solder mask	N.G.	Minor
		The circuit is peeled off or cracked	N.G.	Minor
		There is any circuits risen or exposed.	N.G.	Minor
		$0.2$ mm $<$ Area of solder ball, A is $\leq 0.4$ mm	N.G.	Minor
		The number of solder ball is $\geq 3$ pieces	N.G.	Minor
The magnitude of solder ball, A is $> 0.4$ mm.	N.G.	Minor		

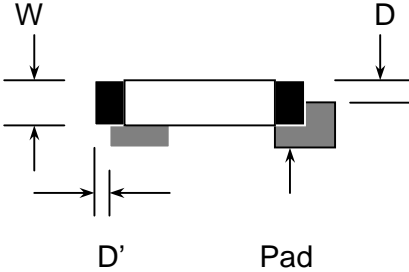
NO	Item	Specification	Judge	Level
6	Appearance of molding $A=(L+W)\div 2$	The shape of modeling is deformed by touching.	N.G.	Major
		Insufficient epoxy: Circuit or pad of IC is visible	N.G.	Minor
		Excessive epoxy: Diameter of modeling is $>20\text{mm}$ or height is $>2.5\text{mm}$	N.G.	Minor
		The diameter of pinhole in modeling, A is $>0.2\text{mm}$ .	N.G.	Minor
7	Appearance of frame $A=(L+W)\div 2$	The folding angle of frame must be $>45^\circ +10^\circ$	N.G.	Minor
		The area of stripped electroplate in top-view of frame, A is $>1.0\text{mm}$ .	N.G.	Minor
		Rust or crack is (Top view only)	N.G.	Minor
		The scratched width of frame is $>0.06\text{mm}$ . (Top view only)	N.G.	Minor
8	Electrical characteristic of backlight $A=(L+W)\div 2$	The color of backlight is nonconforming	N.G.	Major
		Backlight can't work normally.	N.G.	Major
		The LED lamp can't work normally	N.G.	Major
		The unsoldering area of pin for backlight, A is $>1/2$ solder joint area.	N.G.	Minor
		The height of solder pin for backlight is $>2.0\text{mm}$	N.G.	Minor
10	Assembly parts $A=(L+W)\div 2$	The mark or polarity of component is unidentifiable.	N.G.	Minor
		The height between bottom of component and surface of the PCB is floating $>0.7\text{mm}$	N.G.	Minor
		$D > 1/4W$  <p>The diagram shows a component of width W mounted on a pad of width D. The end solder joint width is labeled D'. Arrows indicate the dimensions W, D, and D'.</p>	N.G.	Minor
		End solder joint width, D' is $>50\%$ width of component termination or width of pad	N.G.	Minor
		Side overhang, D is $>25\%$ width of component termination.	N.G.	Minor
		Component is cracked, deformed, and burned, etc.	N.G.	Minor
		The polarity of component is placed in inverse direction.	N.G.	Minor
		Maximum fillet height of solder extends onto the component body or minimum fillet height is $<0.5\text{mm}$ .	N.G.	Minor

## 4. RELIABILITY TEST

### 4.1 Reliability Test Condition

NO	Item	Test Condition	
1	High Temperature Storage	Storage at 80 ±2°C 96~100 hrs Surrounding temperature, then storage at normal condition 4hrs	
2	Low Temperature Storage	Storage at -30 ±2°C 96~100 hrs Surrounding temperature, then storage at normal condition 4hrs	
3	High Temperature /Humidity Storage	1.Storage 96~100 hrs 60±2°C , 90~95%RH surrounding temperature, then storage at normal condition 4hrs. (Excluding the polarizer). or 2.Storage 96~100 hrs 40±2°C , 90~95%RH surrounding temperature, then storage at normal condition 4 hrs.	
4	Temperature Cycling	$-20^{\circ}\text{C} \rightarrow 25^{\circ}\text{C} \rightarrow 70^{\circ}\text{C} \rightarrow 25^{\circ}\text{C}$ $\xleftarrow{(30\text{mins}) (5\text{mins}) (30\text{mins}) (5\text{mins})}$ <p style="text-align: center;">10 Cycle</p>	
5	Vibration	10~55Hz ( 1 minute ) 1.5mm X,Y and Z direction * (each 2hrs)	
6	ESD Test	Air Discharge: Apply 6 KV with 5 times discharge for each polarity +/-	Contact Discharge: Apply 250V with 5 times discharge for each polarity +/-
		Testing location: Around the face of LCD	Testing location: 1.Apply to bezel. 2.Apply to Vdd, Vss.
7	Drop Test	Packing Weight (Kg)	Drop Height (cm)
		0 ~ 45.4	122
		45.4 ~ 90.8	76
		90.8 ~ 454	61
		Over 454	46

## **5. PRECAUTION RELATING PRODUCT HANDLING**

### **5.1 SAFETY**

- 5.1.1 If the LCD panel breaks , be careful not to get the liquid crystal to touch your skin.
- 5.1.2 If the liquid crystal touches your skin or clothes , please wash it off immediately by using soap and water.

### **5.2 HANDLING**

- 5.2.1 Avoid any strong mechanical shock which can break the glass.
- 5.2.2 Avoid static electricity which can damage the CMOS LSI—When working with the module , be sure to ground your body and any electrical equipment you may be using.
- 5.2.3 Do not remove the panel or frame from the module.
- 5.2.4 The polarizing plate of the display is very fragile. So , please handle it very carefully ,do not touch , push or rub the exposed polarizing with anything harder than an HB pencil lead (glass , tweezers , etc.)
- 5.2.5 Do not wipe the polarizing plate with a dry cloth , as it may easily scratch the surface of plate.
- 5.2.6 Do not touch the display area with bare hands , this will stain the display area.
- 5.2.7 Do not use ketonics solvent & aromatic solvent. Use with a soft cloth soaked with a cleaning naphtha solvent.

### **5.3 STORAGE**

- 5.3.1 Store the panel or module in a dark place where the temperature is  $25^{\circ}\text{C} \pm 5^{\circ}\text{C}$  and the humidity is below 65% RH.
- 5.3.2 Do not place the module near organics solvents or corrosive gases.
- 5.3.3 Do not crush , shake , or jolt the module.

### **5.4 TERMS OF WARRANTY**

- 5.4.1 Applicable warrant period  
The period is within thirteen months since the date of shipping out under normal using and storage conditions.
- 5.4.2 Unaccepted responsibility  
This product has been manufactured to your company's specification as a part for use in your company's general electronic products. It is guaranteed to perform according to delivery specifications. For any other use apart from general electronic equipment , we cannot take responsibility if the product is used in nuclear power control equipment , aerospace equipment , fire and security systems or any other applications in which there is a direct risk to human life and where extremely high levels of reliability are required.

## 6. PACKING SPECIFICATION

LCM Model	PG320240WRFDBAHYZQ	<b>LCM包裝規格書</b> LCM Packaging Specifications	Approve	Check	Contact
Drawing NO.	DPK-06471		DATE	初版	版次Ver
			07'09'27	07'09'27	A

### 1. 包裝材料規格表 (Packaging Material) : (per carton)

No.	Item	Model	Dimensions (mm)	Quantity
1	成品(1) (LCM)	PG320240WRFDBAHYZQ	148.02 X 120.24	28
2	氣泡袋(2)	BAG170150BRABA	170 X 150	28
3	A6隔板(3)	BX33800012BZBA	338 X 125 X 3	16
4	B6隔板(4)	BX29800012BZBA	293 X 125 X 3	6
5	海綿墊(5)	OTFOAM00005ABA	330 X 290 X 10	4
6	C4內盒(6)Product Box	BX36031014AABA	360 X 310 X 142	2
7	外紙箱(7)Carton	BX39432432CCBA	394 X 324 X 321	1
8				
9				



### 2. 單箱數量規格表 (Packaging Specifications and Quantity) :

(1) Quantity Of Spacer : A6隔板 X 8 , B6隔板 X 3

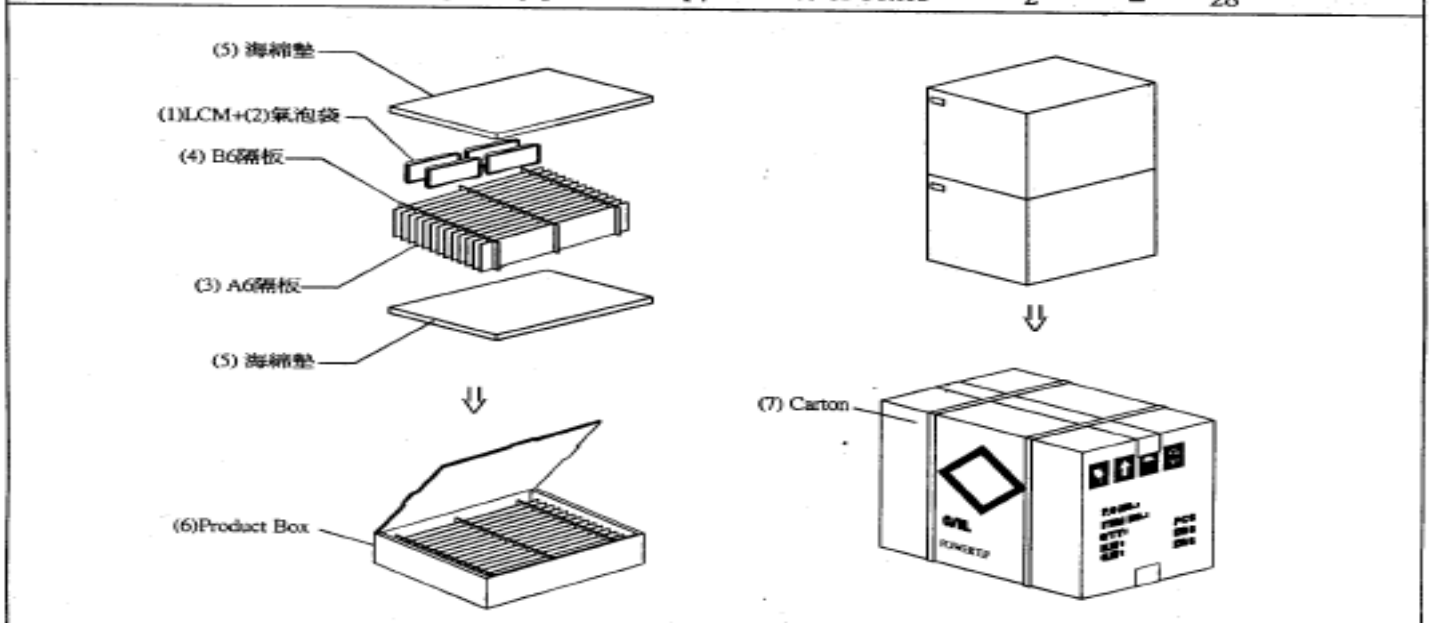
(2) Total LCM quantity in carton : quantity per box 14 x no of boxes 2 = 28

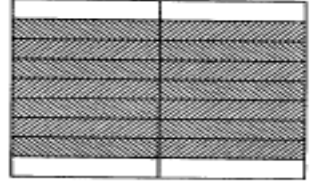

### 特記事項 (REMARK)

<p>1. Label Specifications :</p> <p>MODEL: LOT NO: QUANTITY: CHECK:</p>	<p>2. 每個間隔放1片模組，前後間隔不放置模組。(如放置格示意圖)</p>	<p>3. 放置格示意圖:</p>  <p>1.  模組    2.  空格</p>
---	---	---



# POWERTIP

