

SPECIFICATIONS

CUSTOMER	:	CSE021
SAMPLE CODE	:	SE24064WRM-004-I-Q
MASS PRODUCTION CODE	:	PE24064WRM-004-I-Q
SAMPLE VERSION	:	01
SPECIFICATIONS EDITION	:	002
DRAWING NO. (Ver.)	:	LMD-PE24064WRM-004-I-Q (Ver.001)
PACKAGING NO. (Ver.)	:	PKG-PE24064WRM-004-I-Q (Ver.001)

Customer Approved

Date:

Approved	Checked	Designer
廖志豪 Rex Liao	張慶源 Yuan Chang	陳建成 Louis Chen

- Preliminary specification for design input
- Specification for sample approval

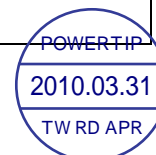

POWER TIP TECH. CORP.

Headquarters:

No.8, 6th Road, Taichung Industrial Park,
 Taichung, Taiwan
 台中市 407 工業區六路 8 號

TEL: 886-4-2355-8168
 FAX: 886-4-2355-8166

E-mail: sales@powertip.com.tw
 Http://www.powertip.com.tw



History of Version

Date (mm / dd / yyyy)	Ver.	Edi.	Description	Page	Design by
12/17/2009	01	001	New drawing.	-	Louis
03/30/2010	01	002	New Sample.	-	Louis
			Modify 1.1 Features.	4	
			Modify 1.4 DC Electrical Characteristics.	5	
			Modify 1.5 Optical Characteristics.	7	

Total : 26 Page



Contents

1. SPECIFICATIONS

- 1.1 Features
- 1.2 Mechanical Specifications
- 1.3 Absolute Maximum Ratings
- 1.4 DC Electrical Characteristics
- 1.5 Optical Characteristics
- 1.6 Backlight Characteristics

2. MODULE STRUCTURE

- 2.1 Counter Drawing
- 2.2 Interface Pin Description
- 2.3 Timing Characteristics

3. QUALITY ASSURANCE SYSTEM

- 3.1 Quality Assurance Flow Chart
- 3.2 Inspection Specification

4. RELIABILITY TEST

- 4.1 Reliability Test Condition

5. PRECAUTION RELATING PRODUCT HANDLING

- 5.1 Safety
- 5.2 Handling
- 5.3 Storage
- 5.4 Terms of Warranty

Appendix :

- 1. LCM drawing
- 2. LCM Packaging Specifications

Note : For detailed information please refer to IC data sheet : Sitronix – ST7586S

1. SPECIFICATIONS

1.1 Features

Item	Standard Value
Display Type	240 * 64 Dots
LCD Type	STN Blue, Negative, Transmissive
Driver Condition	LCD Module :1/64 Duty, 1/9 Bias
Viewing Direction	6 O'clock
Backlight	LED B/L
Weight	43 g
Interface	4-Line serial interface
Driver IC	Sitronix – ST7586S
ROHS	THIS PRODUCT CONFORMS THE ROHS OF PTC Detail information please refer web side : http://www.powertip.com.tw/news/LatestNews.asp

1.2 Mechanical Specifications

Item	Standard Value	Unit
Outline Dimension	120.0(L) * 44.82 (w) * 5.5 (H)	mm
Viewing Area	102.4 (L) * 30.22 (w)	mm
Active Area	98.39 (L) * 26.23 (w)	mm
Dot Size	0.4 (L) * 0.4(w)	mm
Dot Pitch	0.41(L) * 0.41(w)	mm

Note : For detailed information please refer to LCM drawing

1.3 Absolute Maximum Ratings

Item	Symbol	Condition	Min.	Max.	Unit
Power Supply Voltage	VDDI,VDDA	—	-0.3	3.6	V
LCD Driver Supply Voltage	V _{OP}	V0~XV0	-0.3	19	V
Operating Temperature	T _{OP}	—	-20	70	°C
Storage Temperature.	T _{ST}	—	-30	80	°C
Storage Humidity	H _D	T _a < 60 °C	20	90	%RH

1.4 DC Electrical Characteristics

T_a = 25°C

Item	Symbol	Condition	Min.	Typ.	Max.	Unit
Logic Supply Voltage	VDDI VDDA	-	2.7	3.0	3.3	V
“H” Input Voltage	V _{IH}	-	0.7VDDI	-	VDDI	V
“L” Input Voltage	V _{IL}	-	V _{SS}	-	0.3VDDI	V
Supply Current	I _{dd}	V _{DD} = 3.0V;V _{OP} = 10.6V; Pattern= Full display	-	0.9	-	mA
		V _{DD} = 3.0V;V _{OP} = 10.6V; Pattern= Horizontal line *1	-	1.2	2	
LCM Driver Voltage	V _{OP} *2	-20°C	10.7	10.8	10.9	V
		25°C	10.4	10.6	10.8	
		70°C	9.6	9.8	10.0	

NOTE: *1 The Maximum current display;

*2 The VOP test point is V0~XV0.



Instruction	A0	R/W	Command Byte							
			D7	D6	D5	D4	D3	D2	D1	D0
Set Vop	0	0	1	1	0	0	0	0	0	0
	1	0	1	0	1	0	1	1	1	1
	1	0	0	0	0	0	0	0	0	0
Bias System	0	0	1	1	0	0	0	0	1	1
	1	0	0	0	0	0	0	1	0	1
Partial Mode	0	0	0	0	0	1	0	0	1	0
Partial Display	0	0	1	0	1	1	0	1	0	0
	1	0	1	0	1	0	0	0	0	0
Partial Display Area	0	0	0	0	1	1	0	0	0	0
	1	0	0	0	0	0	0	0	0	0
	1	0	0	1	1	0	0	0	0	0
	1	0	0	0	0	0	0	0	0	0
	1	0	1	0	0	1	1	1	1	1

1.5 Optical Characteristics

LCD Panel: 1/64 Duty, 1/9 Bias, $V_{LCD} = 10.6V$, $T_a = 25^\circ C$

Item	Symbol	Conditions	Min.	Typ.	Max.	Unit	Reference	
Response Time	Rise	tr	25°C	-	135	203	ms	Note2
	Fall	tf	25°C	-	155	233		
Viewing angle range	Top	$\theta Y+$	CR \geq 2.0, $\phi = 270^\circ$	-	40	-	degree	Note 1
	Bottom	$\theta Y-$		-	40	-		
	Left	$\theta X-$		-	40	-		
	Right	$\theta X+$		-	40	-		
Contrast Ratio	CR	$\theta = 0^\circ$, $\phi = 270^\circ$	-	6	-	-	Note 3	
Average Brightness (With LED B/L)	IV	IF= 40mA	10	20	-	cd/m ²	-	
CIE Color Coordinate (With LED B/L)	X		0.28	0.33	0.38	-	Note 4	
	Y		0.31	0.36	0.41	-		
Uniformity	ΔB		70	-	-	%		

Note 4:

1 : $\Delta B = B(\text{min}) / B(\text{max}) * 100\%$

2 : Measurement Condition for Optical Characteristics:

a : Environment: 25 \pm 5 / 60 \pm 20%R.H , no wind , dark room below 10 Lux at typical lamp current and typical operating frequency.

b : Measurement Distance: 500 \pm 50 mm , ($\theta = 0^\circ$)

c : Equipment: TOPCON BM-7 fast , (field 1°) , after 10 minutes operation.

d : The uncertainty of the C.I.E coordinate measurement \pm 0.01 , Average Brightness \pm 4%

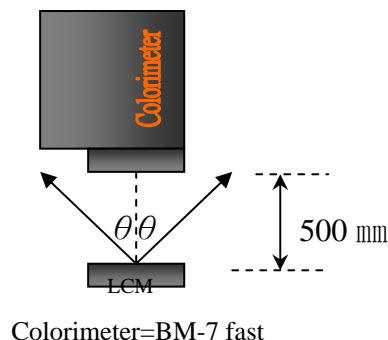
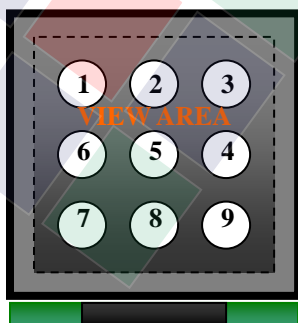

Colorimeter=BM-7 fast



Note 1.

Optical characteristics-2

Viewing angle

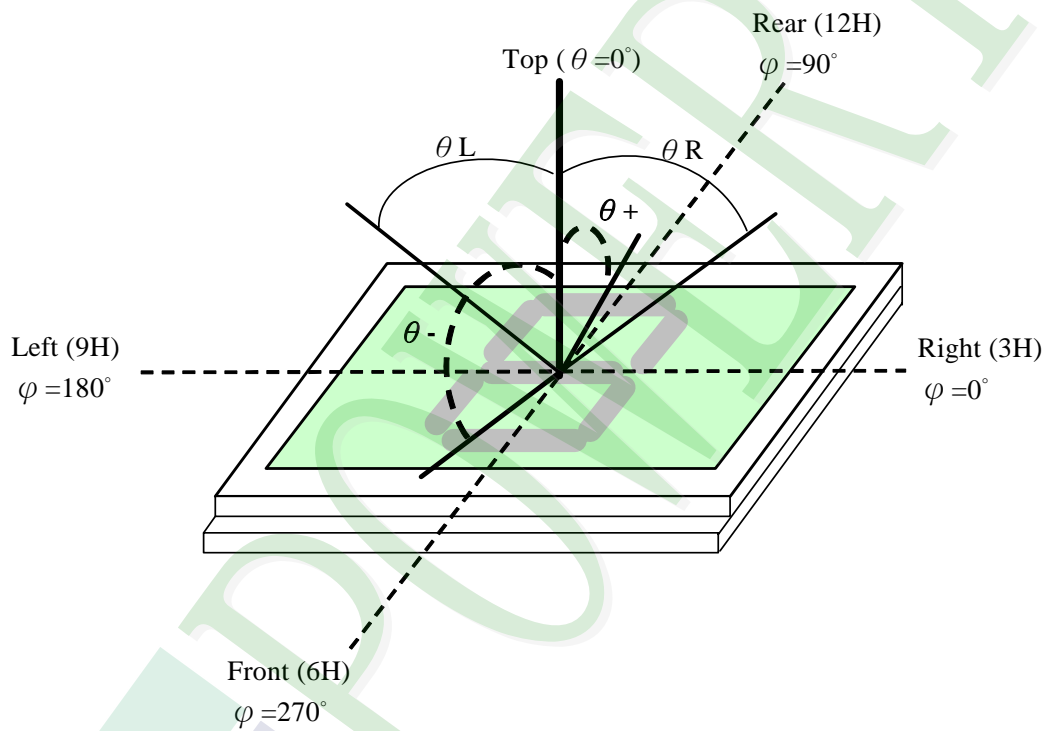

Viewing angle



Note 2.

Optical characteristics-3

Fig.2 Definition of response time

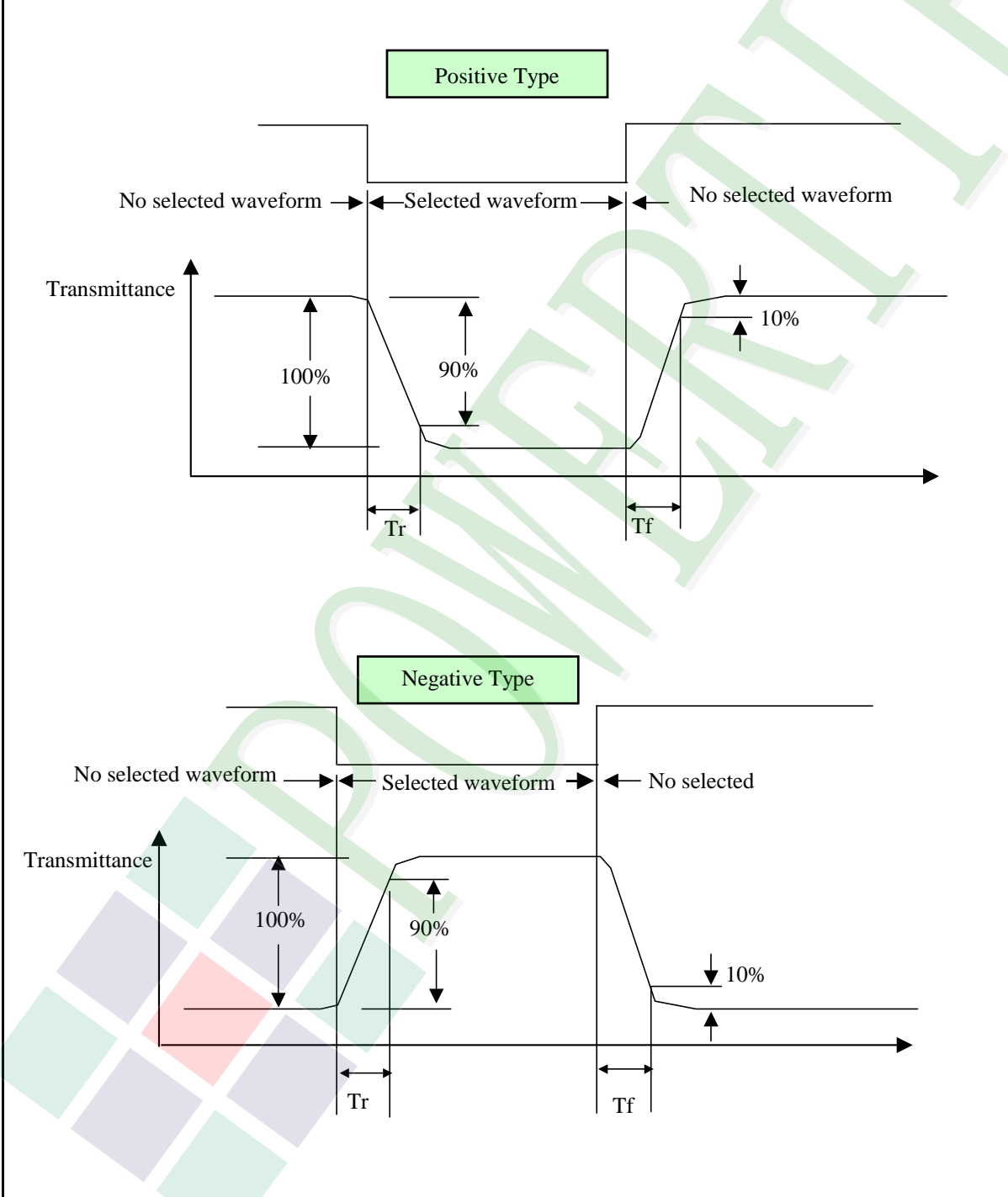



Electrical characteristics-2

2 Drive waveform

V_{op} : Drive voltage

f_F : Frame frequency

$1/B$: Bias

f_D : Drive frequency

N : Duty

(1) Selected waveform

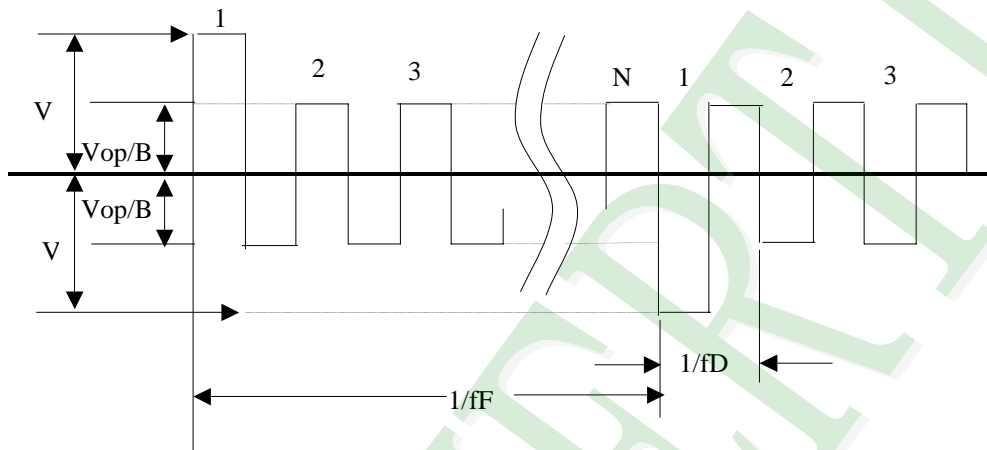

(2) Non- Selected wave form

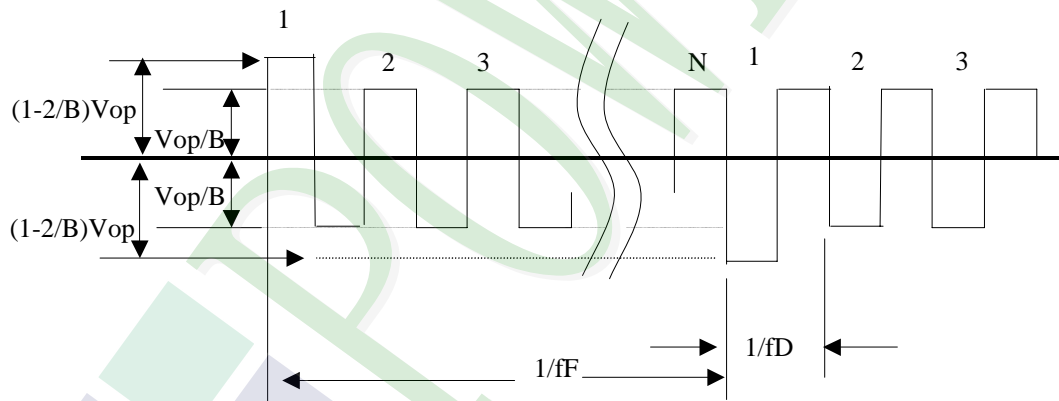

Note:

Frame frequency is defined as follows: Common side supply voltage peak - to - peak / 2 = 1 period



Note 3. : Definition of Vth

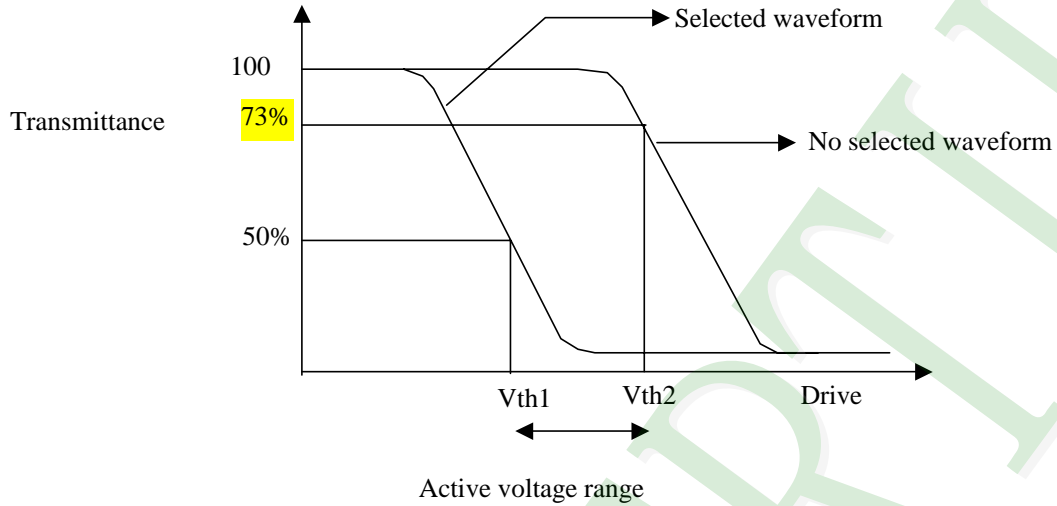

	Vth1	Vth2
View direction	10°	40°
Drive waveform	(Selected waveform)	(No selected waveform)
Transmittance	50%	73%

※1 Contrast ratio
 = (Brightness in OFF state) / (Brightness in ON state)

Outline of Electro-Optical Characteristics Measuring System

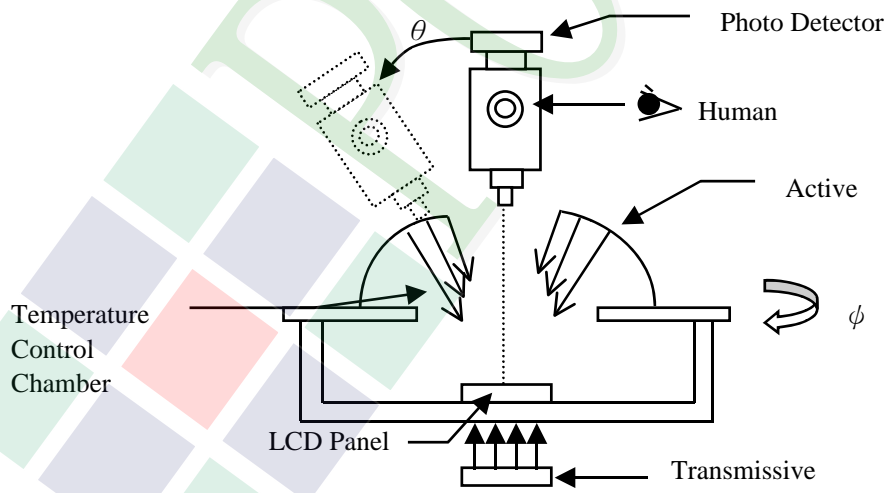

Measuring System: Autronic DMS-803

1.6 Backlight Characteristics

LED Backlight

Maximum Ratings

Item	Symbol	Conditions	Min.	Max.	Unit
Forward Current	I_F	$T_a = 25^\circ\text{C}$	-	60	mA
Reverse Voltage	V_R		-	5	V
Power Dissipation	PD		-	0.3	W
Operating Temperature	T_{OP}	-	-20	70	$^\circ\text{C}$
Storage Temperature.	T_{ST}	-	-30	80	$^\circ\text{C}$

Electrical / Optical Characteristics

$T_a = 25^\circ\text{C}$						
Item	Symbol	Conditions	Min.	Typ.	Max.	Unit
Forward Voltage	V_F	$I_F = 40\text{mA}$	-	4.8	-	V
Reverse Current	I_R	$V_R = 5\text{V}$	-	-	0.1	mA
Average Brightness (Without LCD)	I_V	$I_F = 40\text{mA}$	60	80	-	cd/m^2
CIE Color Coordinate (Without LCD)	X		0.287	-	0.33	-
	Y		0.276	-	0.36	-
Uniformity	ΔB		70	-	-	%
Color	White					

Internal Circuit Diagram:

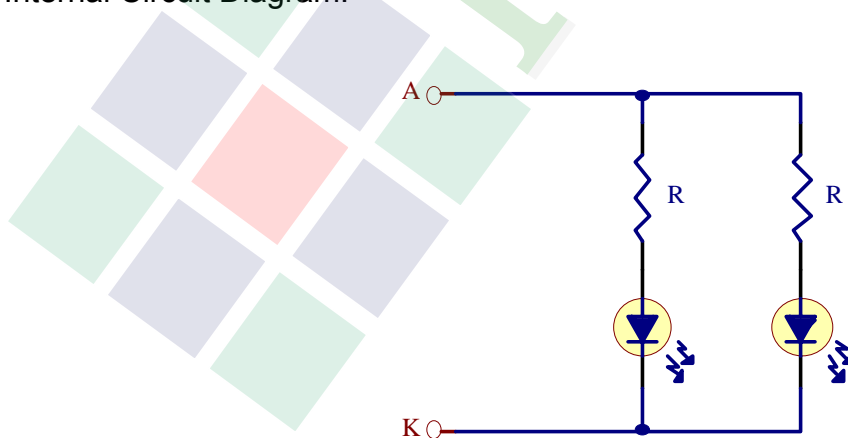

2. MODULE STRUCTURE

2.1 Counter Drawing

2.1.1 LCM Mechanical Diagram

* See Appendix

2.1.2 Block Diagram

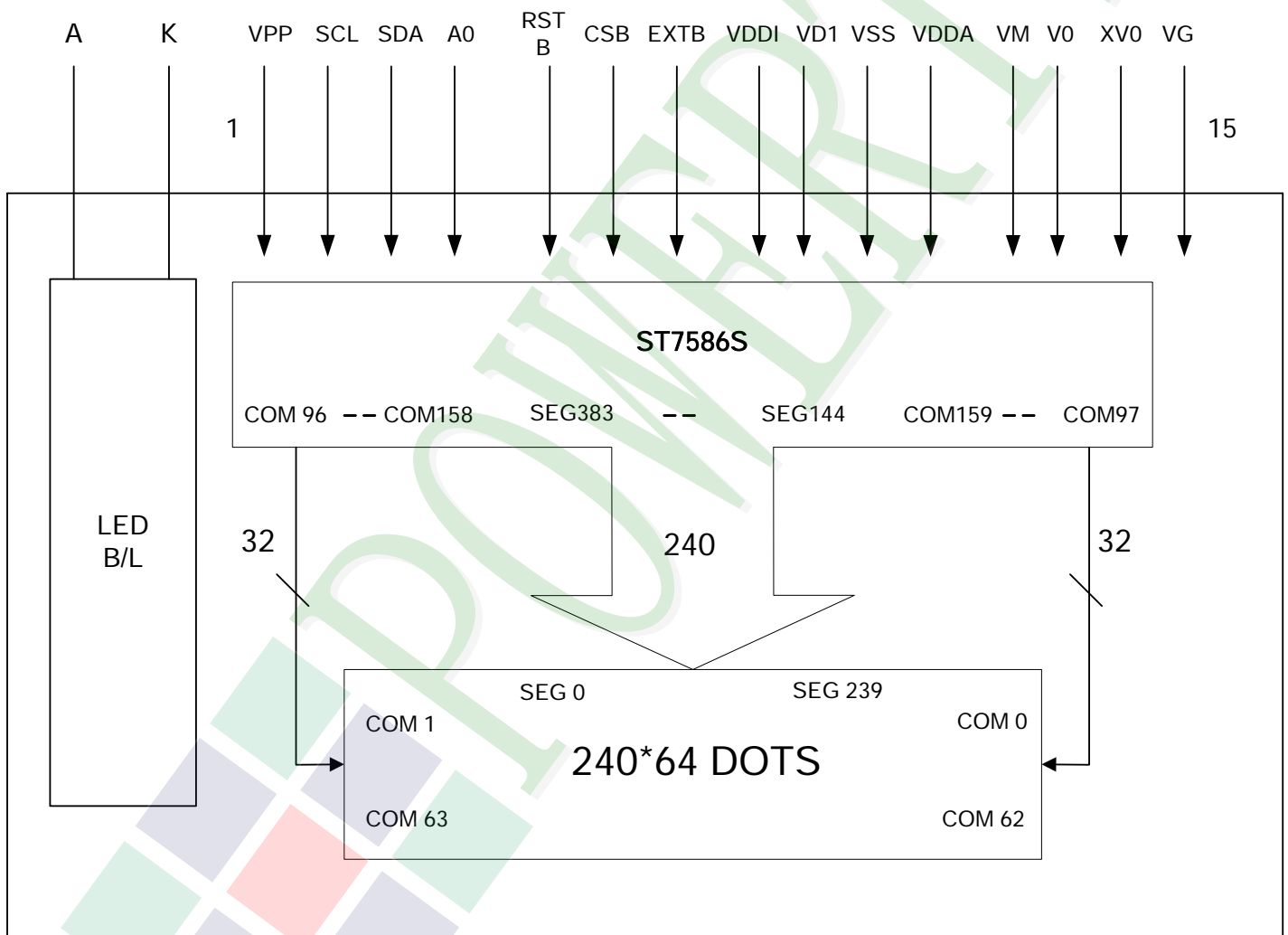

2.2 Interface Pin Description

Pin No.	Symbol	Function
1	VPP	The programming power supply of the built-in OTP.
2	SCL	Serial clock input.
3	SDA	Serial data input.
4	A0	A0 = "H": inputs on data bus are display data; A0 = "L": inputs on data bus are command.
5	RSTB	Reset input pin. When RSTB is "L", internal initialization procedure is executed.
6	CSB	Chip select input pin. CSB="L": This chip is selected and the MPU interface is active. CSB="H": This chip is not selected and the MPU interface is disabled.
7	EXTB	EXTB="L": Enable the extension operation mode. When programming OTP, connect EXTB to VSS1 externally. This pin has an internal pull-high resistor. Please leave this pin OPEN after special operation.
8	VDDI	Digital Power Supply Voltage.
9	VD1	Power source of digital circuits. Connector capacitor to VSS. (C1)
10	VSS	Ground.
11	VDDA	Analog Power supply voltage.
12	VM	VM is the non-select voltage level of COM-drivers. Connector capacitor to VSS. (C2)
13	V0	Positive operating voltage of COM-drivers. Connector capacitor to XV0. (C3)
14	XV0	Negative operating voltage of COM-drivers. Connector capacitor to V0. (C3)
15	VG	VG is the power of SEG-drivers. Connector capacitor to VSS. (C4)

Note :

C1~C4: 1uF /25V

2.3 Timing Characteristics

System Bus Timing for 4-Line SPI MCU Interface

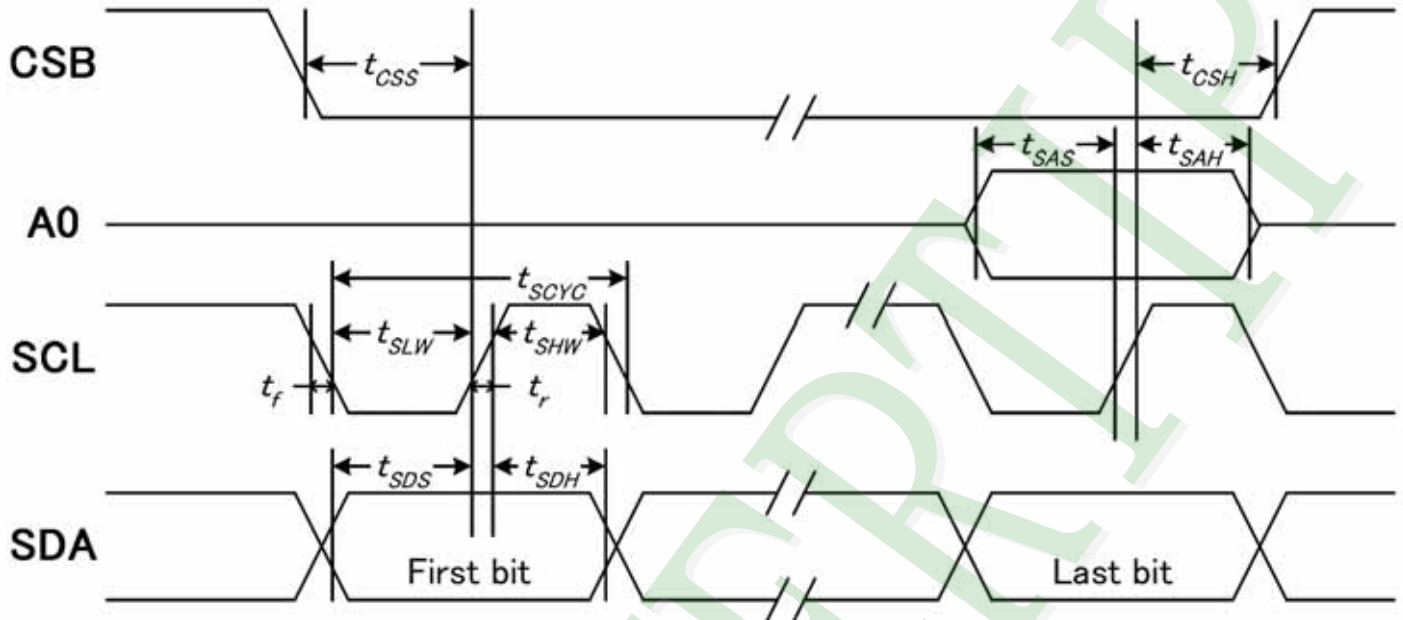

Item	Signal	Symbol	Condition	Min.	Max.	Unit
Serial clock period	SCLK	tSCYC		200	—	ns
SCLK "H" pulse width		tSHW		140	—	
SCLK "L" pulse width		tSLW		60	—	
Address setup time	A0	tSAS		20	—	
Address hold time		tSAH		20	—	
Data setup time	SDA	tSDS		20	—	
Data hold time		tSDH		20	—	
CSB-SCLK time	CSB	tCSS		30	—	
CSB-SCLK time		tCSH		30	—	



Reset Timing

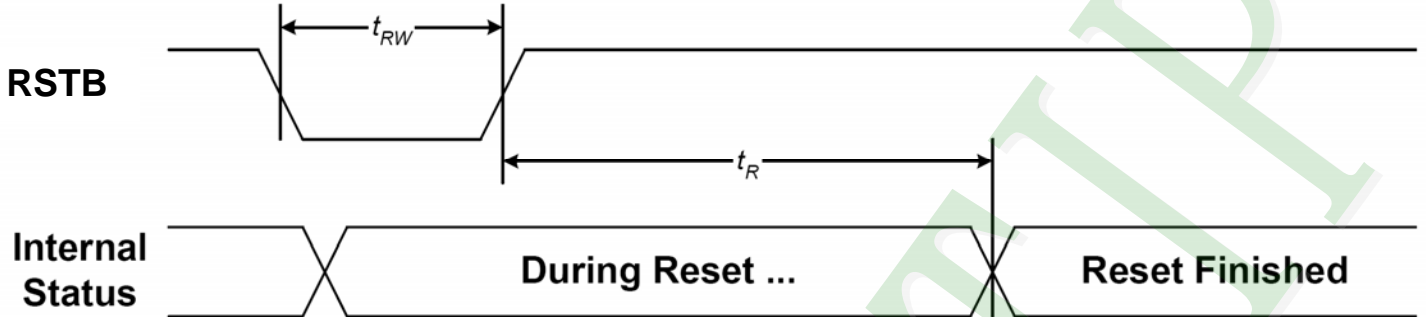

Item	Symbol	Condition	Min.	Max.	Unit
Reset time	t_R		120	—	ms
Reset "L" pulse width	t_{RW}		10	—	us

3. QUALITY ASSURANCE SYSTEM

3.1 Quality Assurance Flow Chart

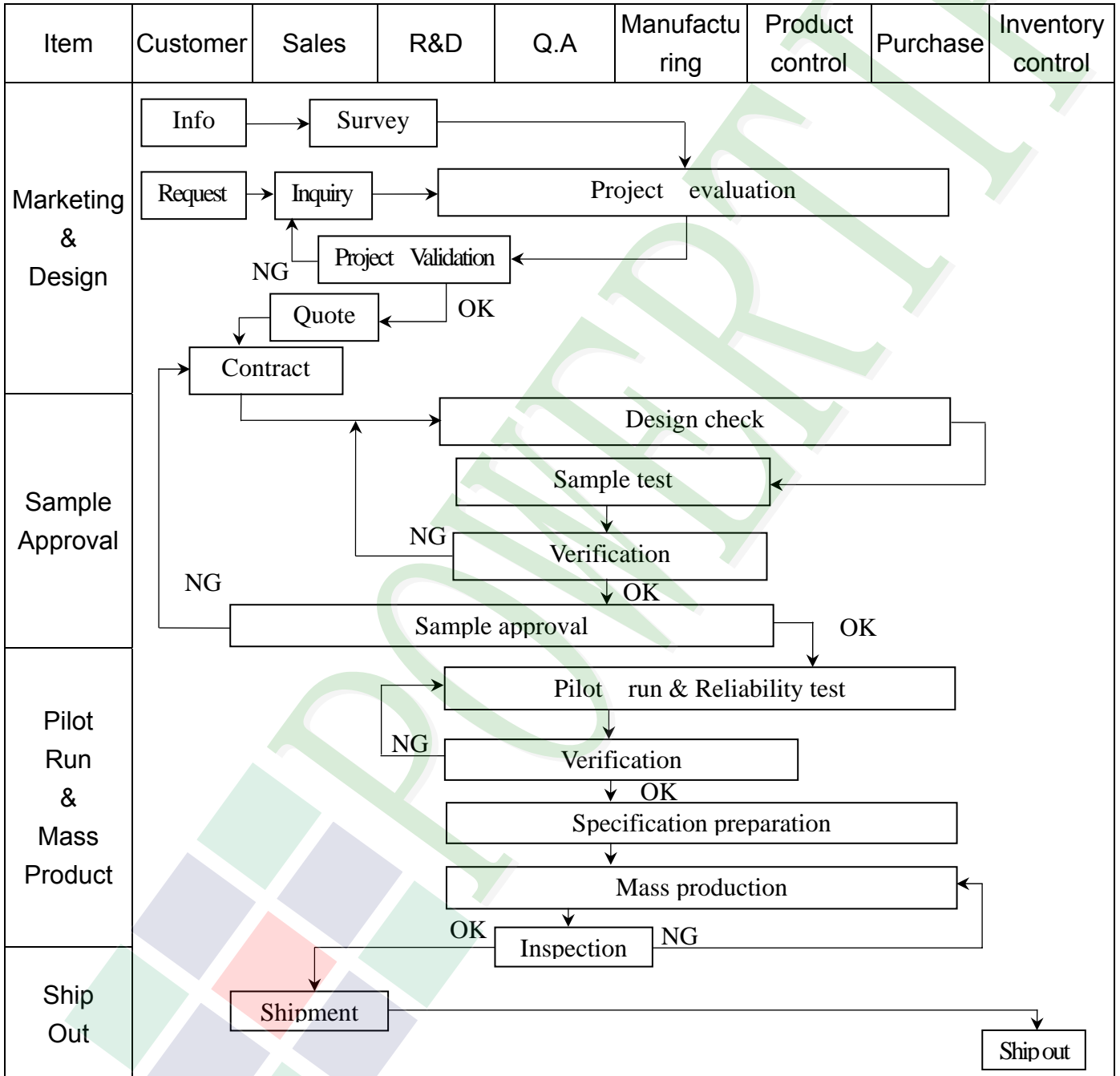



Item	Customer	Sales	R&D	Q.A	Manufacturing	Product control	Purchase	Inventory control
Sales Service	<pre> graph TD Info[Info] --> Claim[Claim] Claim --> FA[Failure analysis] Claim --> AR[Analysis report] FA --> CA[Corrective action] CA --> Tracking[Tracking] </pre>							
Q.A Activity	1. ISO 9001 Maintenance Activities 3. Equipment calibration 5. Standardization Management				2. Process improvement proposal 4. Education And Training Activities			

3.2 Inspection Specification

◆ Scope : The document shall be applied to LCD Module for Monotype and Color STN(Ver. B01).

◆ Inspection Standard : MIL-STD-105E Table Normal Inspection Single Sampling Level II .

◆ Equipment : Gauge 、 MIL-STD 、 Powertip Tester 、 Sample

◆ Defect Level : Major Defect AQL : 0.4 ; Minor Defect : AQL : 1.5 .

◆ OUT Going Defect Level : Sampling .

◆ Manner of appearance test :

- (1). The test be under 20W×2 fluorescent light ' and distance of view must be at 30 cm.
- (2). Standard of inspection : (Unit : mm)
- (3). The test direction is base on about around 45° of vertical line. (Fig. 1)
- (4). Definition of area . (Fig. 2)

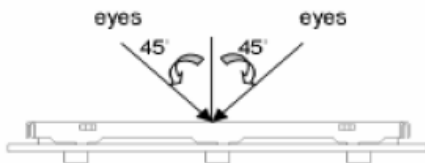

Fig.1

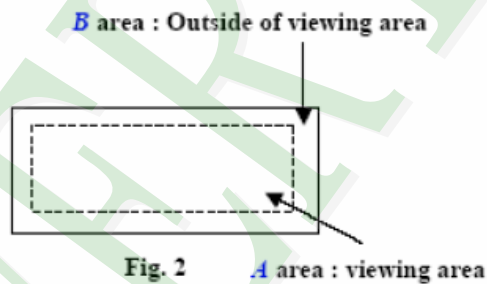

Fig. 2

◆ Specification:

NO	Item	Criterion	Level
01	Product condition	1. 1 The part number is inconsistent with work order of Production.	Major
		1. 2 Mixed production types.	Major
		1. 3 Assembled in inverse direction.	Major
02	Quantity	2. 1 The quantity is inconsistent with work order of production.	Major
03	Outline dimension	3. 1 Product dimension and structure must conform to Structure diagram.	Major
04	Electrical Testing	4. 1 Missing line character and icon.	Major
		4. 2 No function or no display.	Major
		4. 3 Output data is error.	Major
		4. 4 LCD viewing angle defect.	Major
		4. 5 Current consumption exceeds product specifications.	Major

◆Specification For Monotype and Color STN :

(Ver. B01)

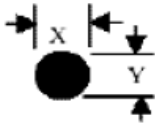
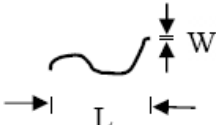
NO	Item	Criterion	Level																																				
05	<p>Black or white dot、scratch、contamination</p> <p>Round type</p>  <p>$\Phi = (x+y)/2$</p> <p>Line type</p> 	<p>5. 1 Round type:</p> <p>5. 1. 1 display only :</p> <ul style="list-style-type: none"> • White and black spots on display ≤ 0.30 mm , no more than 4 white or black spots present. • Densely spaced : NO more than two spots or lines within 3 mm. <p>5. 1. 2 Non-display :</p> <table border="1"> <thead> <tr> <th rowspan="2">Dimension (diameter : Φ)</th> <th colspan="2">Acceptance (Q'ty)</th> </tr> <tr> <th>A area</th> <th>B area</th> </tr> </thead> <tbody> <tr> <td>$\Phi \leq 0.10$</td> <td colspan="2">Accept no dense</td> </tr> <tr> <td>$0.10 < \Phi \leq 0.20$</td> <td>3</td> <td rowspan="3">Ignore</td> </tr> <tr> <td>$0.20 < \Phi \leq 0.30$</td> <td>2</td> </tr> <tr> <td>Total quantity</td> <td>4</td> </tr> </tbody> </table> <p>5. 1. 3 Line type:</p> <table border="1"> <thead> <tr> <th colspan="2">Dimension</th> <th colspan="2">Acceptance (Q'ty)</th> </tr> <tr> <th>Length (L)</th> <th>Width (W)</th> <th>A area</th> <th>B area</th> </tr> </thead> <tbody> <tr> <td>---</td> <td>$W \leq 0.03$</td> <td>Accept no dense</td> <td rowspan="3">Ignore</td> </tr> <tr> <td>$L \leq 3.0$</td> <td>$0.03 < W \leq 0.05$</td> <td rowspan="2">4</td> </tr> <tr> <td>$L \leq 2.5$</td> <td>$0.05 < W \leq 0.075$</td> </tr> <tr> <td>---</td> <td>$W > 0.075$</td> <td colspan="2">As round type</td> </tr> </tbody> </table>	Dimension (diameter : Φ)	Acceptance (Q'ty)		A area	B area	$\Phi \leq 0.10$	Accept no dense		$0.10 < \Phi \leq 0.20$	3	Ignore	$0.20 < \Phi \leq 0.30$	2	Total quantity	4	Dimension		Acceptance (Q'ty)		Length (L)	Width (W)	A area	B area	---	$W \leq 0.03$	Accept no dense	Ignore	$L \leq 3.0$	$0.03 < W \leq 0.05$	4	$L \leq 2.5$	$0.05 < W \leq 0.075$	---	$W > 0.075$	As round type		Minor
Dimension (diameter : Φ)	Acceptance (Q'ty)																																						
	A area	B area																																					
$\Phi \leq 0.10$	Accept no dense																																						
$0.10 < \Phi \leq 0.20$	3	Ignore																																					
$0.20 < \Phi \leq 0.30$	2																																						
Total quantity	4																																						
Dimension		Acceptance (Q'ty)																																					
Length (L)	Width (W)	A area	B area																																				
---	$W \leq 0.03$	Accept no dense	Ignore																																				
$L \leq 3.0$	$0.03 < W \leq 0.05$	4																																					
$L \leq 2.5$	$0.05 < W \leq 0.075$																																						
---	$W > 0.075$	As round type																																					
06	<p>Polarizer Bubble</p>	<table border="1"> <thead> <tr> <th rowspan="2">Dimension (diameter : Φ)</th> <th colspan="2">Acceptance (Q'ty)</th> </tr> <tr> <th>A area</th> <th>B area</th> </tr> </thead> <tbody> <tr> <td>$\Phi \leq 0.20$</td> <td colspan="2">Accept no dense</td> </tr> <tr> <td>$0.20 < \Phi \leq 0.50$</td> <td>3</td> <td rowspan="3">Ignore</td> </tr> <tr> <td>$0.50 < \Phi \leq 1.00$</td> <td>2</td> </tr> <tr> <td>$\Phi > 1.00$</td> <td>0</td> </tr> <tr> <td>Total quantity</td> <td>4</td> <td></td> </tr> </tbody> </table>	Dimension (diameter : Φ)	Acceptance (Q'ty)		A area	B area	$\Phi \leq 0.20$	Accept no dense		$0.20 < \Phi \leq 0.50$	3	Ignore	$0.50 < \Phi \leq 1.00$	2	$\Phi > 1.00$	0	Total quantity	4		Minor																		
Dimension (diameter : Φ)	Acceptance (Q'ty)																																						
	A area	B area																																					
$\Phi \leq 0.20$	Accept no dense																																						
$0.20 < \Phi \leq 0.50$	3	Ignore																																					
$0.50 < \Phi \leq 1.00$	2																																						
$\Phi > 1.00$	0																																						
Total quantity	4																																						



◆ Specification For Monotype and Color STN :

(Ver. B01)

NO	Item	Criterion	Level									
07	The crack of glass	<p>Symbols :</p> <p>X : The length of crack Z : The thickness of crack t : The thickness of glass</p> <p>Y : The width of crack. W : terminal length a : LCD side length</p> <hr/> <p>7.1 General glass chip :</p> <p>7.1.1 Chip on panel surface and crack between panels:</p> <table border="1" data-bbox="507 1574 1307 1861"> <thead> <tr> <th>X</th> <th>Y</th> <th>Z</th> </tr> </thead> <tbody> <tr> <td>$\leq a$</td> <td>Crack can't enter viewing area</td> <td>$\leq 1/2 t$</td> </tr> <tr> <td>$\leq a$</td> <td>Crack can't exceed the half of SP width.</td> <td>$1/2 t < Z \leq 2 t$</td> </tr> </tbody> </table>	X	Y	Z	$\leq a$	Crack can't enter viewing area	$\leq 1/2 t$	$\leq a$	Crack can't exceed the half of SP width.	$1/2 t < Z \leq 2 t$	Minor
X	Y	Z										
$\leq a$	Crack can't enter viewing area	$\leq 1/2 t$										
$\leq a$	Crack can't exceed the half of SP width.	$1/2 t < Z \leq 2 t$										



◆ Specification For Monotype and Color STN :

(Ver. B01)

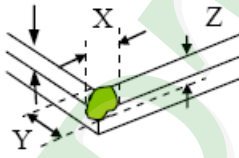
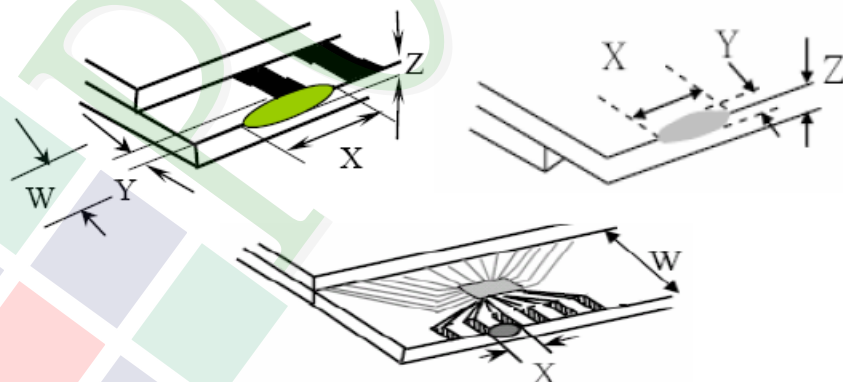
NO	Item	Criterion	Level										
07	The crack of glass	<p>Symbols :</p> <p>X : The length of crack Z : The thickness of crack t : The thickness of glass</p> <p>Y : The width of crack. W : terminal length a : LCD side length</p> <hr/> <p>7.1.2 Corner crack :</p>  <table border="1" data-bbox="502 884 1316 1176"> <thead> <tr> <th>X</th> <th>Y</th> <th>Z</th> </tr> </thead> <tbody> <tr> <td>$\leq 1/5 a$</td> <td>Crack can't enter viewing area</td> <td>$Z \leq 1/2 t$</td> </tr> <tr> <td>$\leq 1/5 a$</td> <td>Crack can't exceed the half of SP width.</td> <td>$1/2 t < Z \leq 2 t$</td> </tr> </tbody> </table>	X	Y	Z	$\leq 1/5 a$	Crack can't enter viewing area	$Z \leq 1/2 t$	$\leq 1/5 a$	Crack can't exceed the half of SP width.	$1/2 t < Z \leq 2 t$	Minor	
		X	Y	Z									
$\leq 1/5 a$	Crack can't enter viewing area	$Z \leq 1/2 t$											
$\leq 1/5 a$	Crack can't exceed the half of SP width.	$1/2 t < Z \leq 2 t$											
<p>7.2 Protrusion over terminal :</p> <p>7.2.1 Chip on electrode pad :</p>  <table border="1" data-bbox="470 1758 1252 1937"> <thead> <tr> <th></th> <th>X</th> <th>Y</th> <th>Z</th> </tr> </thead> <tbody> <tr> <td>Front</td> <td>$\leq a$</td> <td>$\leq 1/2 W$</td> <td>$\leq t$</td> </tr> <tr> <td>Back</td> <td colspan="3">Neglect</td> </tr> </tbody> </table>		X	Y	Z	Front	$\leq a$	$\leq 1/2 W$	$\leq t$	Back	Neglect			
	X	Y	Z										
Front	$\leq a$	$\leq 1/2 W$	$\leq t$										
Back	Neglect												



◆ Specification For Monotype and Color STN :

(Ver. B01)

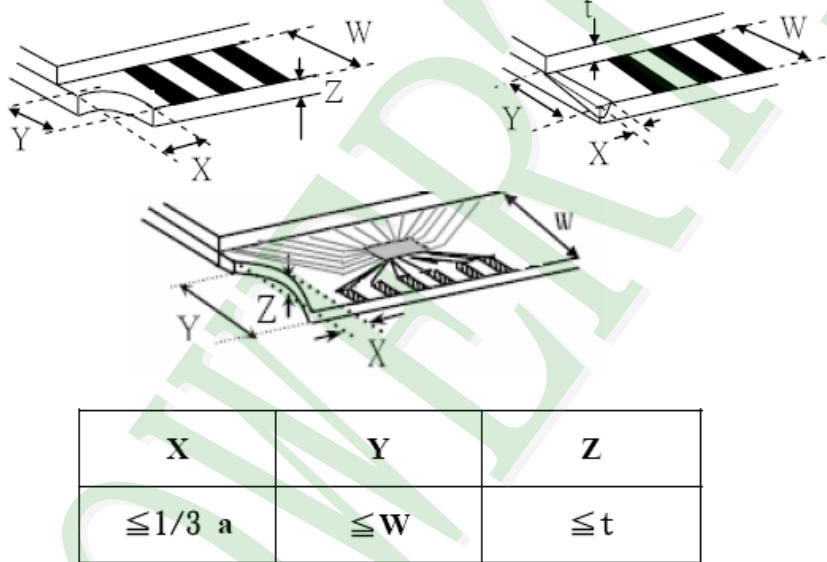
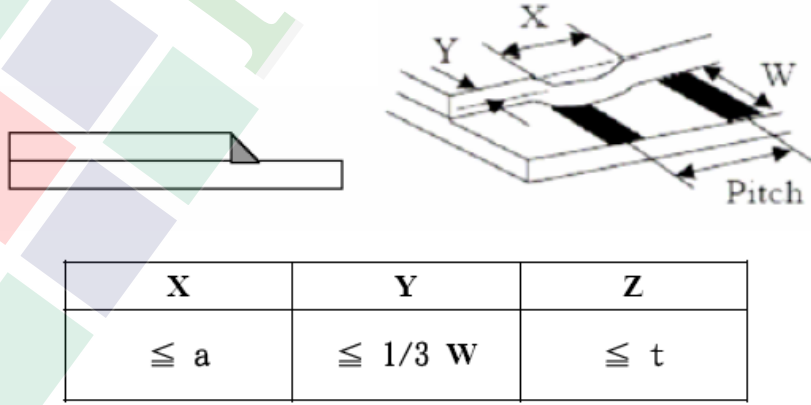
NO	Item	Criterion	Level
07	The crack of glass	<p>Symbols :</p> <p>X : The length of crack Z : The thickness of crack t : The thickness of glass</p> <p>Y : The width of crack. W : terminal length a : LCD side length</p>	Minor
		<p>7.2.2 Non-conductive portion :</p>  <p>⊙ If the chipped area touches the ITO terminal, over 2/3 of the ITO must remain and be inspected according to electrode terminal specifications.</p> <p>7.2.3 Glass remain :</p> 	



◆ Specification For Monotype and Color STN :

(Ver. B01)

NO	Item	Criterion	Level
08	Backlight elements	8. 1 Backlight can't work normally.	Major
		8. 2 Backlight doesn't light or color is wrong.	Major
		8. 3 Illumination source flickers when lit.	Major
09	General appearance	9. 1 Pin type must match type in specification sheet.	Major
		9. 2 No short circuits in components on PCB or FPC.	Major
		9. 3 Product packaging must the same as specified on packaging specification sheet.	Minor
		9. 4 The folding and peeled off in polarizer are not acceptable.	Minor
		9. 5 The PCB or FPC between B/L assembled distance (PCB or FPC) is ≤ 1.5 mm.	Minor



5. PRECAUTION RELATING PRODUCT HANDLING

5.1 SAFETY

- 5.1.1 If the LCD panel breaks , be careful not to get the liquid crystal to touch your skin.
- 5.1.2 If the liquid crystal touches your skin or clothes , please wash it off immediately by using soap and water.

5.2 HANDLING

- 5.2.1 Avoid any strong mechanical shock which can break the glass.
- 5.2.2 Avoid static electricity which can damage the CMOS LSI—When working with the module , be sure to ground your body and any electrical equipment you may be using.
- 5.2.3 Do not remove the panel or frame from the module.
- 5.2.4 The polarizing plate of the display is very fragile. So , please handle it very carefully, do not touch , push or rub the exposed polarizing with anything harder than an HB pencil lead (glass , tweezers , etc.)
- 5.2.5 Do not wipe the polarizing plate with a dry cloth , as it may easily scratch the surface of plate.
- 5.2.6 Do not touch the display area with bare hands , this will stain the display area.
- 5.2.7 Do not use ketonics solvent & aromatic solvent. Use with a soft cloth soaked with a cleaning naphtha solvent.
- 5.2.8 To control temperature and time of soldering is $320 \pm 10^{\circ}\text{C}$ and 3-5 sec.
- 5.2.9 To avoid liquid (include organic solvent) stained on LCM

5.3 STORAGE

- 5.3.1 Store the panel or module in a dark place where the temperature is $25^{\circ}\text{C} \pm 5^{\circ}\text{C}$ and the humidity is below 65% RH.
- 5.3.2 Do not place the module near organics solvents or corrosive gases.
- 5.3.3 Do not crush , shake , or jolt the module.

5.4 TERMS OF WARRANTY

- 5.4.1 Applicable warrant period
The period is within thirteen months since the date of shipping out under normal using and storage conditions.
- 5.4.2 Unaccepted responsibility
This product has been manufactured to your company's specification as a part for use in your company's general electronic products. It is guaranteed to perform according to delivery specifications. For any other use apart from general electronic equipment, we cannot take responsibility if the product is used in nuclear power control equipment, aerospace equipment , fire and security systems or any other applications in which there is a direct risk to human life and where extremely high levels of reliability are required. and where extremely high levels of reliability are required.

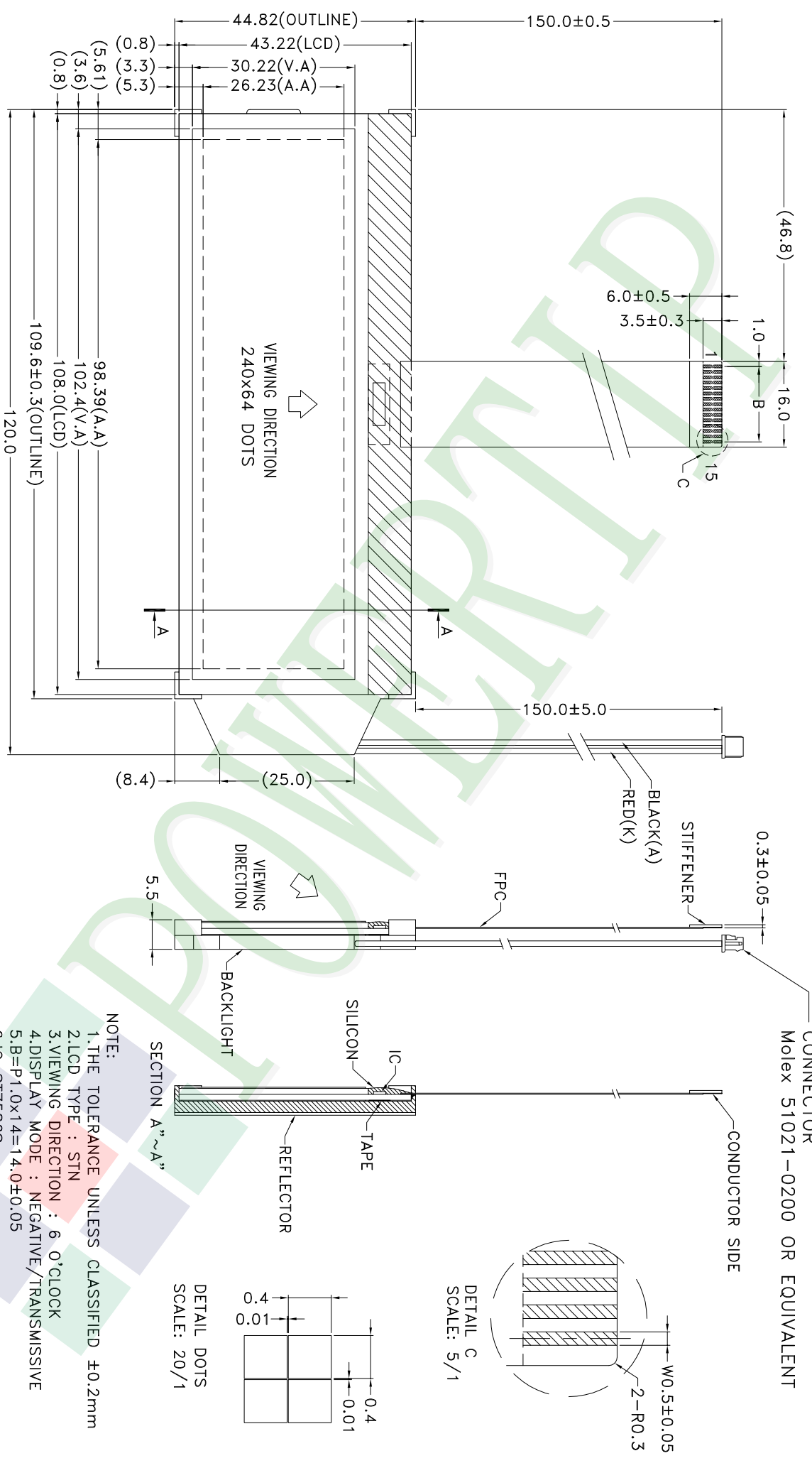

NOTE:
 1. THE TOLERANCE UNLESS CLASSIFIED ±0.2mm
 2. LCD TYPE : STN
 3. VIEWING DIRECTION : 6 O'CLOCK
 4. DISPLAY MODE : NEGATIVE/TRANSMISSIVE
 5. B=P1.0x14=14.0±0.05
 6. IC=ST7586S

PART NO.: PE24064WRM-004-I-Q
 DRAWING NAME : LMD-PE24064WRM-004-I-Q
 TITLE : LCD MODULE DRAWING

久正光電股份有限公司
 POWER TIP TECHNOLOGY CORPORATION

Design	Stone	Unit	MM	Surface	1 ~ 4	Precision Level	-
Check	Mag	Scale	1:1	Material	4 ~ 16		-
Approve	Linda	Page	1/1	Thickness	16 ~ 63		-
		Quantity			63 ~ 250		-
					250 ~ 1000		-

007							
006							
005							
004							
003							
002							
001	NEW DRAWING	Stone	2009/12/16	REVISER	DATE		
REV		REV BY					

1. 包裝材料規格表 (Packaging Material) : (per carton)

No.	Item	Model	Dimensions (mm)	1Pcs Weight	Quantity	Total Weight
1	成品LCM	PE24064WRM-004-I-Q	120 X 44.82	0.043	48	2.064
2	抗靜電氣泡袋(1)Bubble Bag	BAG200160BRABA	200 X 160	0.0096	48	0.4608
3	A4隔板(2)A4 Partition	BX24500070BNBA	245 X 70 X 2.5	0.014	16	0.224
4	B4隔板(3)B4 Partition	BX29300070BLBA	293 X 70 X 2.5	0.012	56	0.672
5	氣泡紙(4)Bubble Sheet	BAG280240BWABA	280 X 240	0.006	16	0.096
6	C2內盒(5)Product Box	BX31025580AABA	310 X 255 X 80	0.221	8	1.768
7	外紙箱(6)Carton	BX52732536CCBA	527 X 325 X 360	1.092	1	1.092
8						
9						

2. 一整箱總重量 (Total LCD Weight in carton) : 6.38 Kg±10%

3. 單箱數量規格表 (Packaging Specifications and Quantity) :

(1) Quantity Of Spacer : A4隔板 X 2 , B2隔板 X 7

(2) Total LCM quantity in carton : quantity per box 6 x no of boxes 8 = 48

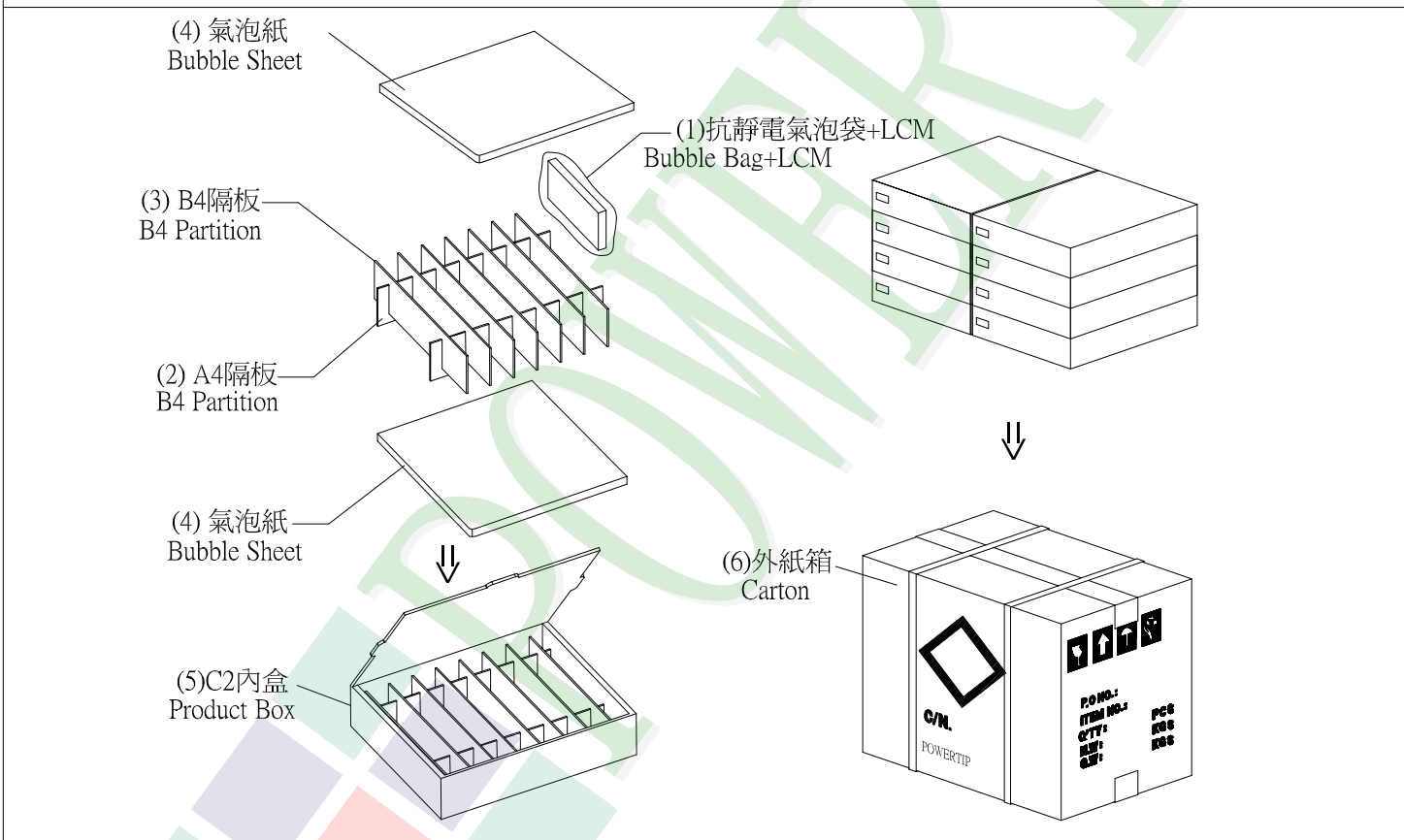

特 記 事 項 (REMARK)

<p>1. Label Specifications :</p> <div style="border: 1px solid black; padding: 5px; margin-top: 10px;"> <p>MODEL:</p> <p>LOT NO:</p> <p>QUANTITY:</p> <p>CHECK:</p> </div>	
--	--