



The Infinite Bandwidth Company™

## MIC5219

### 500mA-Peak Output LDO Regulator

#### General Description

The MIC5219 is an efficient linear voltage regulator with high peak output current capability, very low dropout voltage, and better than 1% output voltage accuracy. Dropout is typically 10mV at light loads and less than 500mV at full load.

The MIC5219 is designed to provide a peak output current for startup conditions where higher inrush current is demanded. It features a 500mA peak output rating. Continuous output current is limited only by package and layout.

The MIC5219 can be enabled or shut down by a CMOS or TTL compatible signal. When disabled, power consumption drops nearly to zero. Dropout ground current is minimized to help prolong battery life. Other key features include reversed-battery protection, current limiting, overtemperature shutdown, and low noise performance with an ultra-low-noise option.

The MIC5219 is available in adjustable or fixed output voltages in space-saving SOT-23-5 and MM8™ 8-lead power MSOP packages. For higher power requirements see the MIC5209 or MIC5237.

#### Features

- Guaranteed 500mA-peak output over the full operating temperature range
- Low 500mV maximum dropout voltage at full load
- Extremely tight load and line regulation
- Tiny SOT-23-5 and MM8™ power MSOP-8 package
- Ultra-low-noise output
- Low temperature coefficient
- Current and thermal limiting
- Reversed-battery protection
- CMOS/TTL-compatible enable/shutdown control
- Near-zero shutdown current

#### Applications

- Laptop, notebook, and palmtop computers
- Cellular telephones and battery-powered equipment
- Consumer and personal electronics
- PC Card  $V_{CC}$  and  $V_{PP}$  regulation and switching
- SMPS post-regulator/dc-to-dc modules
- High-efficiency linear power supplies

#### Typical Applications

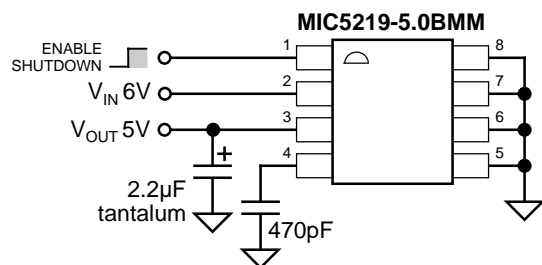

5V Ultra-Low-Noise Regulator

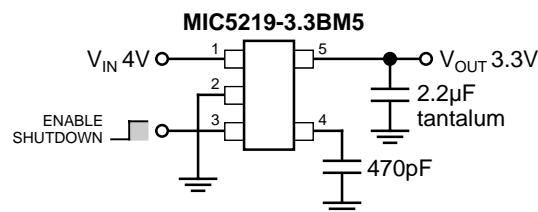

3.3V Ultra-Low-Noise Regulator

## Ordering Information

| Part Number    | Marking | Volts | Junction Temp. Range | Package  |
|----------------|---------|-------|----------------------|----------|
| MIC5219-3.0BMM | —       | 3.0V  | -40°C to +125°C      | MSOP-8   |
| MIC5219-3.3BMM | —       | 3.3V  | -40°C to +125°C      | MSOP-8   |
| MIC5219-3.6BMM | —       | 3.6V  | -40°C to +125°C      | MSOP-8   |
| MIC5219-5.0BMM | —       | 5.0V  | -40°C to +125°C      | MSOP-8   |
| MIC5219BMM     | —       | Adj.  | -40°C to +125°C      | MSOP-8   |
| MIC5219-2.6BM5 | LG26    | 2.6V  | -40°C to +125°C      | SOT-23-5 |
| MIC5219-2.7BM5 | LG27    | 2.7V  | -40°C to +125°C      | SOT-23-5 |
| MIC5219-2.8BM5 | LG28    | 2.8V  | -40°C to +125°C      | SOT-23-5 |
| MIC5219-2.9BM5 | LG29    | 2.9V  | -40°C to +125°C      | SOT-23-5 |
| MIC5219-3.0BM5 | LG30    | 3.0V  | -40°C to +125°C      | SOT-23-5 |
| MIC5219-3.3BM5 | LG33    | 3.3V  | -40°C to +125°C      | SOT-23-5 |
| MIC5219-3.6BM5 | LG36    | 3.6V  | -40°C to +125°C      | SOT-23-5 |
| MIC5219-5.0BM5 | LG50    | 5.0V  | -40°C to +125°C      | SOT-23-5 |
| MIC5219BM5     | LGAA    | Adj.  | -40°C to +125°C      | SOT-23-5 |

Other voltages available. Consult Micrel for details.

## Pin Configuration

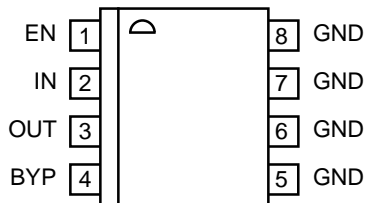

**MIC5219-x.xBMM**  
MM8™ MSOP-8  
Fixed Voltages

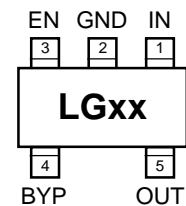

**MIC5219-x.xBM5**  
SOT-23-5  
Fixed Voltages

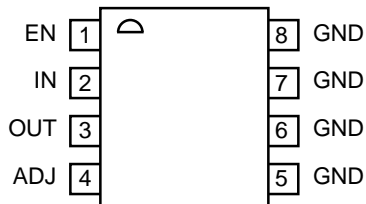

**MIC5219BMM**  
MM8™ MSOP-8  
Adjustable Voltage

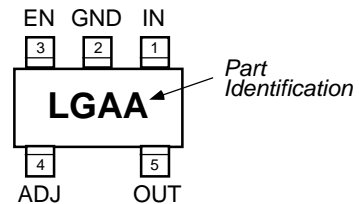

**MIC5219BM5**  
SOT-23-5  
Adjustable Voltage

## Pin Description

| Pin No.<br>MSOP-8 | Pin No.<br>SOT-23-5 | Pin Name | Pin Function  |
|-------------------|---------------------|----------|---|
| 2                 | 1                   | IN       | Supply Input  |
| 5-8               | 2                   | GND      | Ground: MSOP-8 pins 5 through 8 are internally connected.   |
| 3                 | 5                   | OUT      | Regulator Output  |
| 1                 | 3                   | EN       | Enable (Input): CMOS compatible control input. Logic high = enable; logic low or open = shutdown.   |
| 4 (fixed)         | 4 (fixed)           | BYP      | Reference Bypass: Connect external 470pF capacitor to GND to reduce output noise. May be left open. |
| 4 (adj.)          | 4 (adj.)            | ADJ      | Adjust (Input): Feedback input. Connect to resistive voltage-divider network.                       |

## Absolute Maximum Ratings

|                                      |                    |
|--------------------------------------|--------------------|
| Supply Input Voltage ( $V_{IN}$ )    | –20V to +20V       |
| Power Dissipation ( $P_D$ )          | Internally Limited |
| Junction Temperature ( $T_J$ )       | –40°C to +125°C    |
| Lead Temperature (Soldering, 5 sec.) | 260°C              |

## Operating Ratings

|                                   |                 |
|-----------------------------------|-----------------|
| Supply Input Voltage ( $V_{IN}$ ) | +2.5V to +12V   |
| Enable Input Voltage ( $V_{EN}$ ) | 0V to $V_{IN}$  |
| Junction Temperature ( $T_J$ )    | –40°C to +125°C |
| Package Thermal Resistance        | see Table 1     |

## Electrical Characteristics

$V_{IN} = V_{OUT} + 1.0V$ ;  $C_{OUT} = 4.7\mu F$ ,  $I_{OUT} = 100\mu A$ ;  $T_J = 25^\circ C$ , **bold** values indicate  $-40^\circ C \leq T_J \leq +125^\circ C$ ; unless noted.

| Symbol                      | Parameter                                   | Conditions  | Min      | Typical   | Max                | Units           |
|-----------------------------|---|---|----------|-----------|--------------------|-----------------|
| $V_{OUT}$                   | Output Voltage Accuracy                     | variation from nominal $V_{OUT}$                            | –1<br>–2 |           | 1<br>2             | %<br>%          |
| $\Delta V_{OUT}/\Delta T$   | Output Voltage Temperature Coefficient      | <b>Note 2</b>   |          | <b>40</b> |                    | ppm/°C          |
| $\Delta V_{OUT}/V_{OUT}$    | Line Regulation                             | $V_{IN} = V_{OUT} + 1V$ to 12V                              |          | 0.009     | 0.05<br><b>0.1</b> | %/V             |
| $\Delta V_{OUT}/V_{OUT}$    | Load Regulation                             | $I_{OUT} = 100\mu A$ to 500mA <b>Note 3</b>                 |          | 0.05      | 0.5<br><b>0.7</b>  | %               |
| $V_{IN} - V_{OUT}$          | Dropout Voltage, <b>Note 4</b>              | $I_{OUT} = 100\mu A$  |          | 10        | 60<br><b>80</b>    | mV              |
|                             |   | $I_{OUT} = 50mA$  |          | 115       | 175<br><b>250</b>  | mV              |
|                             |   | $I_{OUT} = 150mA$   |          | 175       | 300<br><b>400</b>  | mV              |
|                             |   | $I_{OUT} = 500mA$   |          | 350       | 500<br><b>600</b>  | mV              |
| $I_{GND}$                   | Ground Pin Current, <b>Notes 5, 6</b>       | $V_{EN} \geq 3.0V$ , $I_{OUT} = 100\mu A$                   |          | 80        | 130<br><b>170</b>  | $\mu A$         |
|                             |   | $V_{EN} \geq 3.0V$ , $I_{OUT} = 50mA$                       |          | 350       | 650<br><b>900</b>  | $\mu A$         |
|                             |   | $V_{EN} \geq 3.0V$ , $I_{OUT} = 150mA$                      |          | 1.8       | 2.5<br><b>3.0</b>  | mA              |
|                             |   | $V_{EN} \geq 3.0V$ , $I_{OUT} = 500mA$                      |          | 12        | 20<br><b>25</b>    | mA              |
|                             | Ground Pin Quiescent Current, <b>Note 6</b> | $V_{EN} \leq 0.4V$  |          | 0.05      | <b>3</b>           | $\mu A$         |
|                             | $V_{EN} \leq 0.18V$                         |   | 0.10     | <b>8</b>  | $\mu A$            |                 |
| PSRR                        | Ripple Rejection                            | $f = 120Hz$   |          | 75        |                    | dB              |
| $I_{LIMIT}$                 | Current Limit                               | $V_{OUT} = 0V$  |          | 700       | <b>1000</b>        | mA              |
| $\Delta V_{OUT}/\Delta P_D$ | Thermal Regulation                          | <b>Note 7</b>   |          | 0.05      |                    | %/W             |
| $e_{no}$                    | Output Noise                                | $I_{OUT} = 50mA$ , $C_{OUT} = 2.2\mu F$ , $C_{BYP} = 0$     |          | 500       |                    | nV/ $\sqrt{Hz}$ |
|                             |   | $I_{OUT} = 50mA$ , $C_{OUT} = 2.2\mu F$ , $C_{BYP} = 470pF$ |          | 300       |                    | nV/ $\sqrt{Hz}$ |

### ENABLE Input

|           |                                |  |     |             |                    |         |
|-----------|--------------------------------|--|-----|-------------|--------------------|---------|
| $V_{ENL}$ | Enable Input Logic-Low Voltage | $V_{EN} = \text{logic low (regulator shutdown)}$ |     |             | 0.4<br><b>0.18</b> | V       |
|           |                                | $V_{EN} = \text{logic high (regulator enabled)}$ | 2.0 |             |                    | V       |
| $I_{ENL}$ | Enable Input Current           | $V_{ENL} \leq 0.4V$                              |     | 0.01        | –1                 | $\mu A$ |
|           |                                | $V_{ENL} \leq 0.18V$                             |     | <b>0.01</b> | –2                 | $\mu A$ |
| $I_{ENH}$ |                                | $V_{ENH} \geq 2.0V$                              | 2   | 5           | 20<br><b>25</b>    | $\mu A$ |

- Note 1:** Absolute maximum ratings indicate limits beyond which damage to the component may occur. Electrical specifications do not apply when operating the device outside of its operating ratings. The maximum allowable power dissipation is a function of the maximum junction temperature,  $T_{J(max)}$ , the junction-to-ambient thermal resistance,  $\theta_{JA}$ , and the ambient temperature,  $T_A$ . The maximum allowable power dissipation at any ambient temperature is calculated using:  $P_{D(max)} = (T_{J(max)} - T_A) \div \theta_{JA}$ . Exceeding the maximum allowable power dissipation will result in excessive die temperature, and the regulator will go into thermal shutdown. See Table 1 and the "Thermal Considerations" section for details.
- Note 2:** Output voltage temperature coefficient is defined as the worst case voltage change divided by the total temperature range.
- Note 3:** Regulation is measured at constant junction temperature using low duty cycle pulse testing. Parts are tested for load regulation in the load range from 100 $\mu$ A to 500mA. Changes in output voltage due to heating effects are covered by the thermal regulation specification.
- Note 4:** Dropout voltage is defined as the input to output differential at which the output voltage drops 2% below its nominal value measured at 1V differential.
- Note 5:** Ground pin current is the regulator quiescent current plus pass transistor base current. The total current drawn from the supply is the sum of the load current plus the ground pin current.
- Note 6:**  $V_{EN}$  is the voltage externally applied to devices with the EN (enable) input pin.
- Note 7:** Thermal regulation is defined as the change in output voltage at a time "t" after a change in power dissipation is applied, excluding load or line regulation effects. Specifications are for a 500mA load pulse at  $V_{IN} = 12V$  for  $t = 10ms$ .
- Note 8:**  $C_{BYP}$  is an optional, external bypass capacitor connected to devices with a BYP (bypass) or ADJ (adjust) pin.

# Typical Characteristics

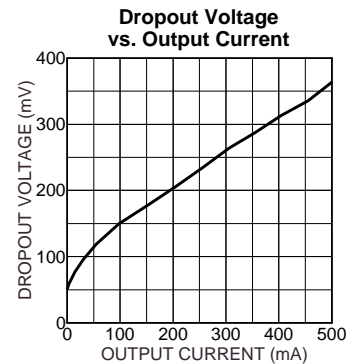
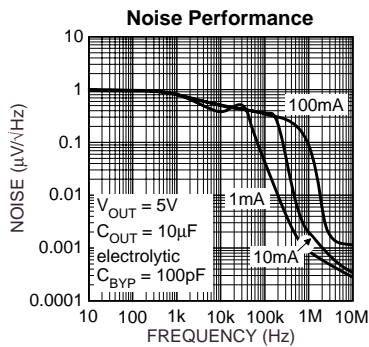
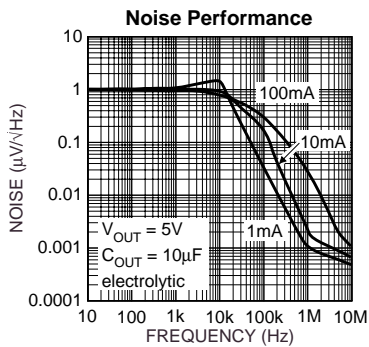
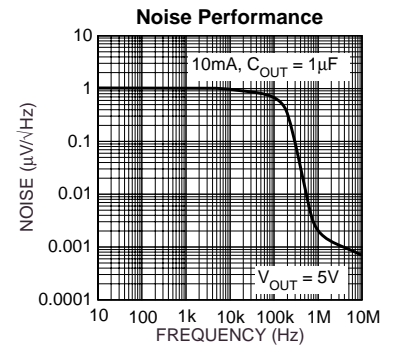
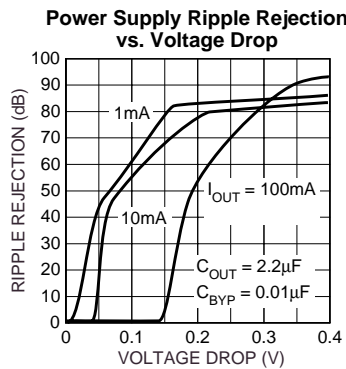
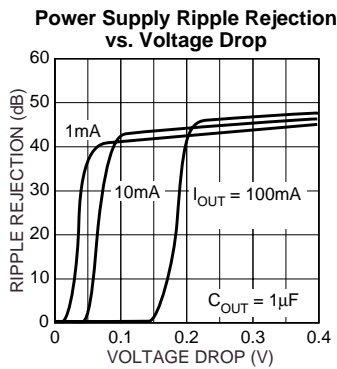
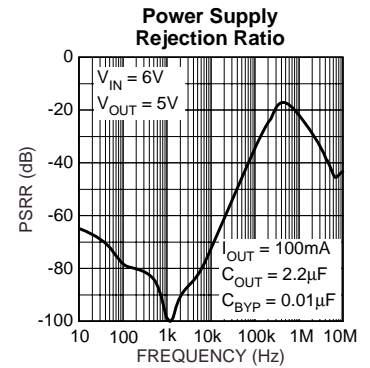
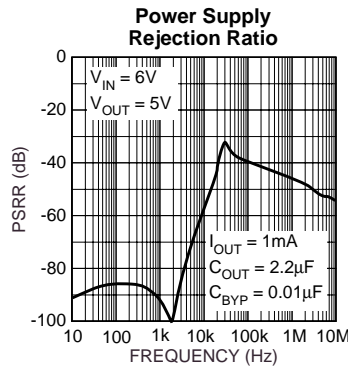
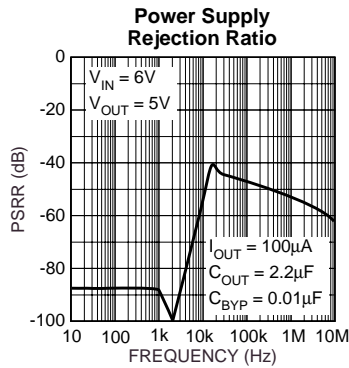
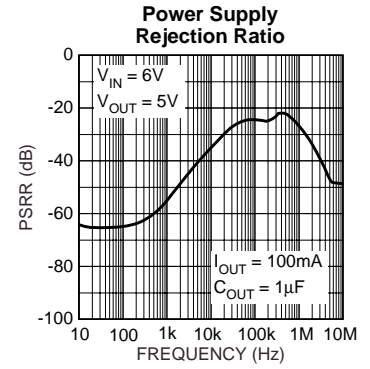
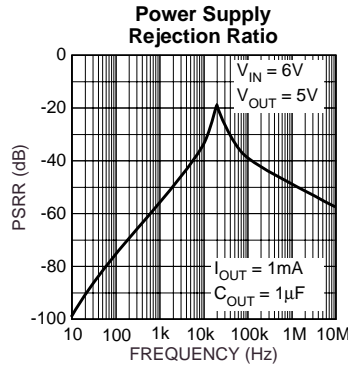
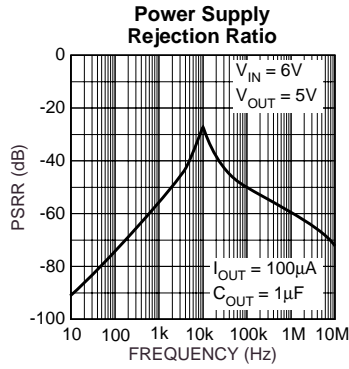

**Dropout Characteristics**

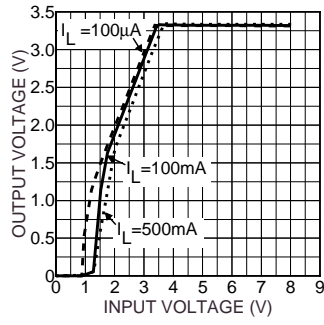

**Ground Current vs. Output Current**

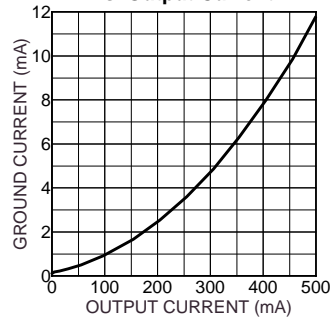

**Ground Current vs. Supply Voltage**

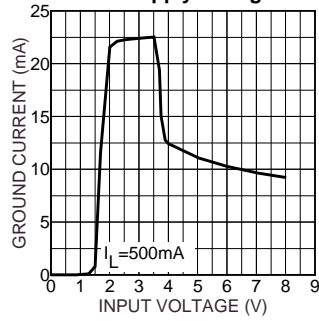

**Ground Current vs. Supply Voltage**

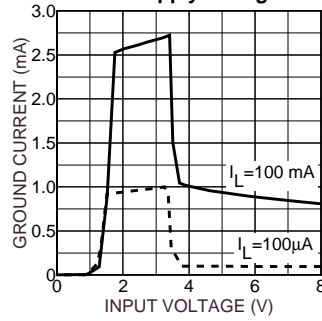

# Block Diagrams

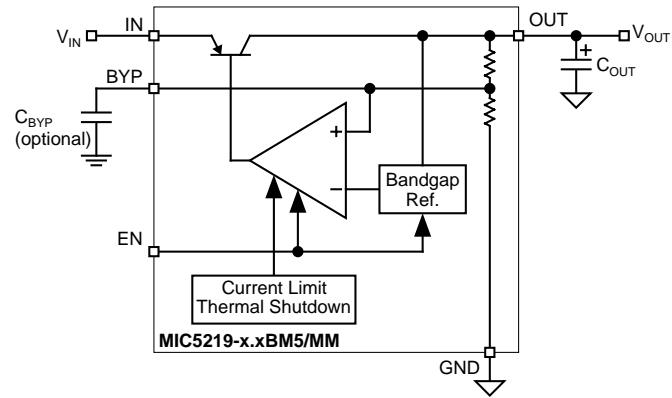

**Ultra-Low-Noise Fixed Regulator**

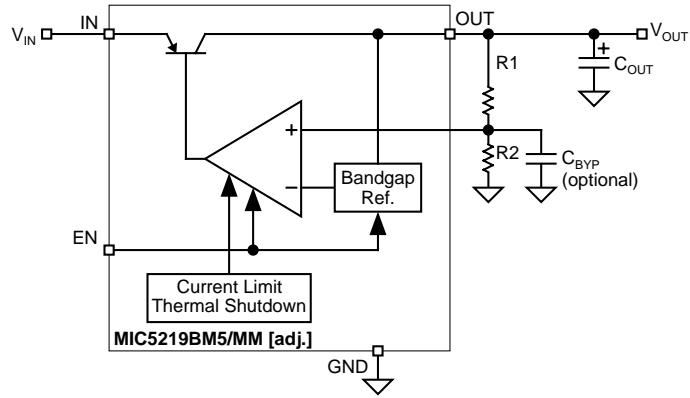

**Ultra-Low-Noise Adjustable Regulator**

## Applications Information

The MIC5219 is designed for 150mA to 200mA output current applications where a high current spike (500mA) is needed for short, startup conditions. Basic application of the device will be discussed initially followed by a more detailed discussion of higher current applications.

### Enable/Shutdown

Forcing EN (enable/shutdown) high (> 2V) enables the regulator. EN is compatible with CMOS logic. If the enable/shutdown feature is not required, connect EN to IN (supply input). See Figure 5.

### Input Capacitor

A 1μF capacitor should be placed from IN to GND if there is more than 10 inches of wire between the input and the ac filter capacitor or if a battery is used as the input.

### Output Capacitor

An output capacitor is required between OUT and GND to prevent oscillation. The minimum size of the output capacitor is dependent upon whether a reference bypass capacitor is used. 1μF minimum is recommended when C<sub>BYP</sub> is not used (see Figure 5). 2.2μF minimum is recommended when C<sub>BYP</sub> is 470pF (see Figure 6). For applications <3V, the output capacitor should be increased to 22μF minimum to reduce start-up overshoot. Larger values improve the regulator's transient response. The output capacitor value may be increased without limit.

The output capacitor should have an ESR (equivalent series resistance) of about 5Ω or less and a resonant frequency above 1MHz. Ultra-low-ESR capacitors could cause oscillation and/or underdamped transient response. Most tantalum or aluminum electrolytic capacitors are adequate; film types will work, but are more expensive. Many aluminum electrolytics have electrolytes that freeze at about -30°C, so solid tantalums are recommended for operation below -25°C.

At lower values of output current, less output capacitance is needed for stability. The capacitor can be reduced to 0.47μF for current below 10mA or 0.33μF for currents below 1mA.

### No-Load Stability

The MIC5219 will remain stable and in regulation with no load (other than the internal voltage divider) unlike many other voltage regulators. This is especially important in CMOS RAM keep-alive applications.

### Reference Bypass Capacitor

BYP is connected to the internal voltage reference. A 470pF capacitor (C<sub>BYP</sub>) connected from BYP to GND quiets this reference, providing a significant reduction in output noise (ultra-low-noise performance). C<sub>BYP</sub> reduces the regulator phase margin; when using C<sub>BYP</sub>, output capacitors of 2.2μF or greater are generally required to maintain stability.

The start-up speed of the MIC5219 is inversely proportional to the size of the reference bypass capacitor. Applications requiring a slow ramp-up of output voltage should consider larger values of C<sub>BYP</sub>. Likewise, if rapid turn-on is necessary, consider omitting C<sub>BYP</sub>.

## Thermal Considerations

The MIC5219 is designed to provide 200mA of continuous current in two very small profile packages. Maximum power dissipation can be calculated based on the output current and the voltage drop across the part. To determine the maximum power dissipation of the package, use the thermal resistance, junction-to-ambient, of the device and the following basic equation.

$$P_{D(\max)} = \frac{(T_{J(\max)} - T_A)}{\theta_{JA}}$$

T<sub>J(MAX)</sub> is the maximum junction temperature of the die, 125°C, and T<sub>A</sub> is the ambient operating temperature. θ<sub>JA</sub> is layout dependent; table 1 shows examples of thermal resistance, junction-to-ambient, for the MIC5219.

| Package       | θ <sub>JA</sub> Recommended Minimum Footprint | θ <sub>JA</sub> 1" Square 2 oz. Copper | θ <sub>JC</sub> |
|---------------|---|--|-----------------|
| MM8™ (MM)     | 160°C/W                                       | 70°C/W                                 | 30°C/W          |
| SOT-23-5 (M5) | 220°C/W                                       | 170°C/W                                | 130°C/W         |

**Table 1. MIC5219 Thermal Resistance**

The actual power dissipation of the regulator circuit can be determined using one simple equation.

$$P_D = (V_{IN} - V_{OUT}) I_{OUT} + V_{IN} I_{GND}$$

Substituting P<sub>D(MAX)</sub> for P<sub>D</sub> and solving for the operating conditions that are critical to the application will give the maximum operating conditions for the regulator circuit. For example, if we are operating the MIC5219-3.3BM5 at room temperature, with a minimum footprint layout, we can determine the maximum input voltage for a set output current.

$$P_{D(\max)} = \frac{(125^\circ\text{C} - 25^\circ\text{C})}{220^\circ\text{C/W}}$$

$$P_{D(\max)} = 455\text{mW}$$

The thermal resistance, junction-to-ambient, for the minimum footprint is 220°C/W, taken from table 1. The maximum power dissipation number cannot be exceeded for proper operation of the device. Using the output voltage of 3.3V, and an output current of 150mA, we can determine the maximum input voltage. Ground current, maximum of 3mA for 150mA of output current, can be taken from the Electrical Characteristics section of the data sheet.

$$455\text{mW} = (V_{IN} - 3.3\text{V}) \times 150\text{mA} + V_{IN} \times 3\text{mA}$$

$$455\text{mW} = (150\text{mA}) \times V_{IN} + 3\text{mA} \times V_{IN} - 495\text{mW}$$

$$950\text{mW} = 153\text{mA} \times V_{IN}$$

$$V_{IN} = 6.2V_{\text{MAX}}$$

Therefore, a 3.3V application at 150mA of output current can accept a maximum input voltage of 6.2V in a SOT-23-5 package. For a full discussion of heat sinking and thermal effects on voltage regulators, refer to the Regulator Thermals section of Micrel's *Designing with Low-Dropout Voltage Regulators* handbook.



## Peak Current Applications

The MIC5219 is designed for applications where high start-up currents are demanded from space constrained regulators. This device will deliver 500mA start-up current from a SOT-23-5 or MM8 package, allowing high power from a very low profile device. The MIC5219 can subsequently provide output current that is only limited by the thermal characteristics of the device. You can obtain higher continuous currents from the device with the proper design. This is easily proved with some thermal calculations.

If we look at a specific example, it may be easier to follow. The MIC5219 can be used to provide up to 500mA continuous output current. First, calculate the maximum power dissipation of the device, as was done in the thermal considerations section. Worst case thermal resistance ( $\theta_{JA} = 220^{\circ}\text{C/W}$  for the MIC5219-x.xBM5), will be used for this example.

$$P_{D(\max)} = \frac{(T_{J(\max)} - T_A)}{\theta_{JA}}$$

Assuming a 25°C room temperature, we have a maximum power dissipation number of

$$P_{D(\max)} = \frac{(125^{\circ}\text{C} - 25^{\circ}\text{C})}{220^{\circ}\text{C/W}}$$

$$P_{D(\max)} = 455\text{mW}$$

Then we can determine the maximum input voltage for a five-volt regulator operating at 500mA, using worst case ground current.

$$P_{D(\max)} = 455\text{mW} = (V_{IN} - V_{OUT}) I_{OUT} + V_{IN} I_{GND}$$

$$I_{OUT} = 500\text{mA}$$

$$V_{OUT} = 5\text{V}$$

$$I_{GND} = 20\text{mA}$$

$$455\text{mW} = (V_{IN} - 5\text{V}) 500\text{mA} + V_{IN} \times 20\text{mA}$$

$$2.955\text{W} = 520\text{mA} \times V_{IN}$$

$$V_{IN(\max)} = \frac{2.955\text{W}}{520\text{mA}} = 5.683\text{V}$$

Therefore, to be able to obtain a constant 500mA output current from the 5219-5.0BM5 at room temperature, you need extremely tight input-output voltage differential, barely above the maximum dropout voltage for that current rating.

You can run the part from larger supply voltages if the proper precautions are taken. Varying the duty cycle using the enable pin can increase the power dissipation of the device by maintaining a lower average power figure. This is ideal for applications where high current is only needed in short bursts. Figure 1 shows the safe operating regions for the MIC5219-x.xBM5 at three different ambient temperatures and at different output currents. The data used to determine this figure assumed a minimum footprint PCB design for minimum heat sinking. Figure 2 incorporates the same factors as the first figure, but assumes a much better heat sink. A 1" square copper trace on the PC board reduces the thermal resistance of the device. This improved thermal resistance improves power dissipation and allows for a larger safe operating region.

Figures 3 and 4 show safe operating regions for the MIC5219-x.xBMM, the power MSOP package part. These graphs show three typical operating regions at different temperatures. The lower the temperature, the larger the operating region. The graphs were obtained in a similar way to the graphs for the MIC5219-x.xBM5, taking all factors into consideration and using two different board layouts, minimum footprint and 1" square copper PC board heat sink. (For further discussion of PC board heat sink characteristics, refer to Application Hint 17, "Designing PC Board Heat Sinks".)

The information used to determine the safe operating regions can be obtained in a similar manner to that used in determining typical power dissipation, already discussed. Determining the maximum power dissipation based on the layout is the first step, this is done in the same manner as in the previous two sections. Then, a larger power dissipation number multiplied by a set maximum duty cycle would give that maximum power dissipation number for the layout. This is best shown through an example. If the application calls for 5V at 500mA for short pulses, but the only supply voltage available is 8V, then the duty cycle has to be adjusted to determine an average power that does not exceed the maximum power dissipation for the layout.

$$\text{Avg. } P_D = \left( \frac{\% \text{ DC}}{100} \right) (V_{IN} - V_{OUT}) I_{OUT} + V_{IN} I_{GND}$$

$$455\text{mW} = \left( \frac{\% \text{ DC}}{100} \right) (8\text{V} - 5\text{V}) 500\text{mA} + 8\text{V} \times 20\text{mA}$$

$$455\text{mW} = \left( \frac{\% \text{ Duty Cycle}}{100} \right) 1.66\text{W}$$

$$0.274 = \frac{\% \text{ Duty Cycle}}{100}$$

$$\% \text{ Duty Cycle Max} = 27.4\%$$

With an output current of 500mA and a three-volt drop across the MIC5219-xxBMM, the maximum duty cycle is 27.4%.

Applications also call for a set nominal current output with a greater amount of current needed for short durations. This is a tricky situation, but it is easily remedied. Calculate the average power dissipation for each current section, then add the two numbers giving the total power dissipation for the regulator. For example, if the regulator is operating normally at 50mA, but for 12.5% of the time it operates at 500mA output, the total power dissipation of the part can be easily determined. First, calculate the power dissipation of the device at 50mA. We will use the MIC5219-3.3BM5 with 5V input voltage as our example.

$$P_D \times 50\text{mA} = (5\text{V} - 3.3\text{V}) \times 50\text{mA} + 5\text{V} \times 650\mu\text{A}$$

$$P_D \times 50\text{mA} = 173\text{mW}$$

However, this is continuous power dissipation, the actual on-time for the device at 50mA is (100%-12.5%) or 87.5% of the time, or 87.5% duty cycle. Therefore,  $P_D$  must be multiplied by the duty cycle to obtain the actual average power dissipation at 50mA.

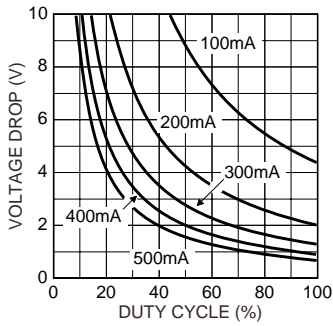

a. 25°C Ambient

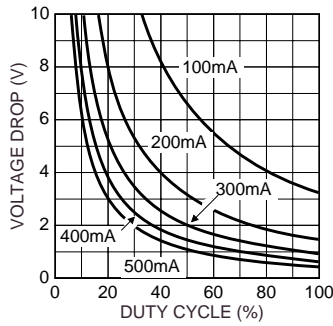

b. 50°C Ambient

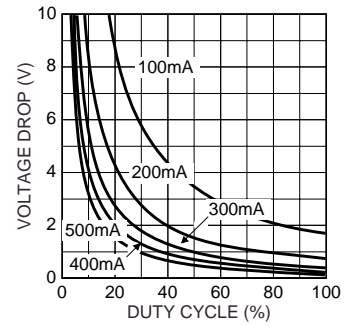

c. 85°C Ambient

Figure 1. MIC5219-x.xBM5 (SOT-23-5) on Minimum Recommended Footprint

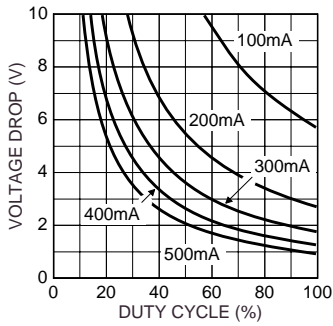

a. 25°C Ambient

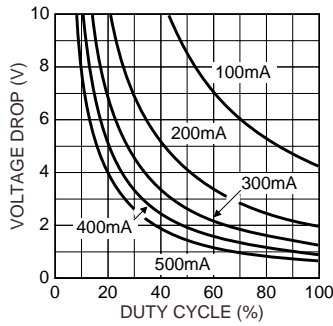

b. 50°C Ambient

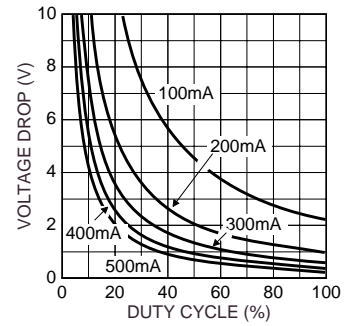

c. 85°C Ambient

Figure 2. MIC5219-x.xBM5 (SOT-23-5) on 1-inch<sup>2</sup> Copper Cladding

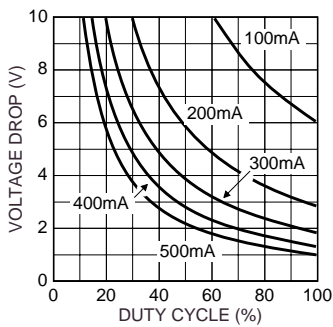

a. 25°C Ambient

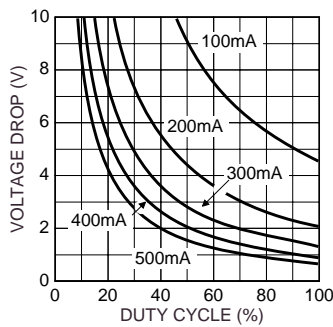

b. 50°C Ambient

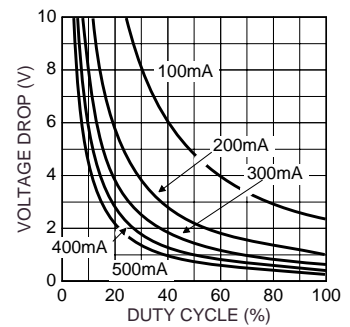

c. 85°C Ambient

Figure 3. MIC5219-x.xBMM (MSOP-8) on Minimum Recommended Footprint

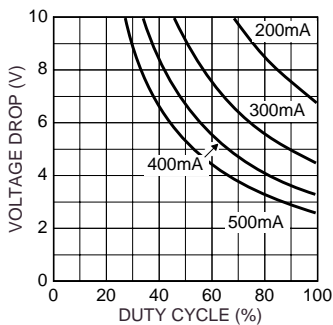

a. 25°C Ambient

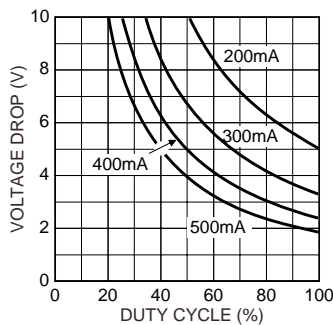

b. 50°C Ambient

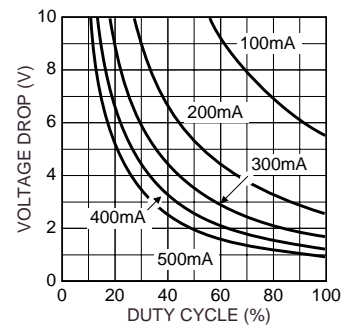

c. 85°C Ambient

Figure 4. MIC5219-x.xBMM (MSOP-8) on 1-inch<sup>2</sup> Copper Cladding

$$P_D \times 50\text{mA} = 0.875 \times 173\text{mW}$$

$$P_D \times 50\text{mA} = 151\text{mW}$$

The power dissipation at 500mA must also be calculated.

$$P_D \times 500\text{mA} = (5\text{V} - 3.3\text{V}) 500\text{mA} + 5\text{V} \times 20\text{mA}$$

$$P_D \times 500\text{mA} = 950\text{mW}$$

This number must be multiplied by the duty cycle at which it would be operating, 12.5%.

$$P_D \times = 0.125 \times 950\text{mW}$$

$$P_D \times = 119\text{mW}$$

The total power dissipation of the device under these conditions is the sum of the two power dissipation figures.

$$P_{D(\text{total})} = P_D \times 50\text{mA} + P_D \times 500\text{mA}$$

$$P_{D(\text{total})} = 151\text{mW} + 119\text{mW}$$

$$P_{D(\text{total})} = 270\text{mW}$$

The total power dissipation of the regulator is less than the maximum power dissipation of the SOT-23-5 package at room temperature, on a minimum footprint board and therefore would operate properly.

Multilayer boards with a ground plane, wide traces near the pads, and large supply-bus lines will have better thermal conductivity.

For additional heat sink characteristics, please refer to Micrel Application Hint 17, "Designing P.C. Board Heat Sinks", included in Micrel's *Databook*. For a full discussion of heat sinking and thermal effects on voltage regulators, refer to Regulator Thermals section of Micrel's *Designing with Low-Dropout Voltage Regulators* handbook.

**Fixed Regulator Circuits**

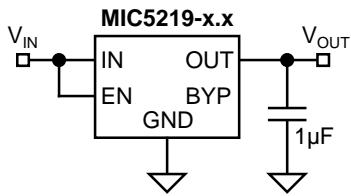

**Figure 5. Low-Noise Fixed Voltage Regulator**

Figure 5 shows a basic MIC5219-x.xBMX fixed-voltage regulator circuit. A 1µF minimum output capacitor is required for basic fixed-voltage applications.

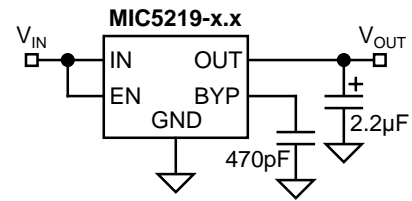

**Figure 6. Ultra-Low-Noise Fixed Voltage Regulator**

Figure 6 includes the optional 470pF noise bypass capacitor between BYP and GND to reduce output noise. Note that the minimum value of C<sub>OUT</sub> must be increased when the bypass capacitor is used.

**Adjustable Regulator Circuits**

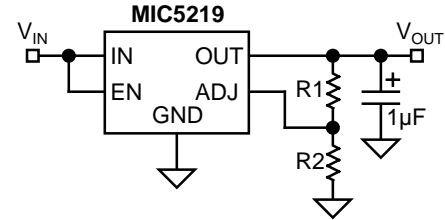
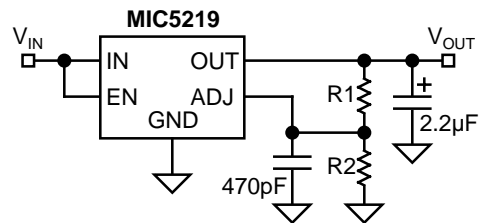

**Figure 7. Low-Noise Adjustable Voltage Regulator**

Figure 7 shows the basic circuit for the MIC5219 adjustable regulator. The output voltage is configured by selecting values for R1 and R2 using the following formula:

$$V_{OUT} = 1.242\text{V} \left( \frac{R2}{R1} + 1 \right)$$

Although ADJ is a high-impedance input, for best performance, R2 should not exceed 470kΩ.



**Figure 8. Ultra-Low-Noise Adjustable Application.**

Figure 8 includes the optional 470pF bypass capacitor from ADJ to GND to reduce output noise.

Package Information

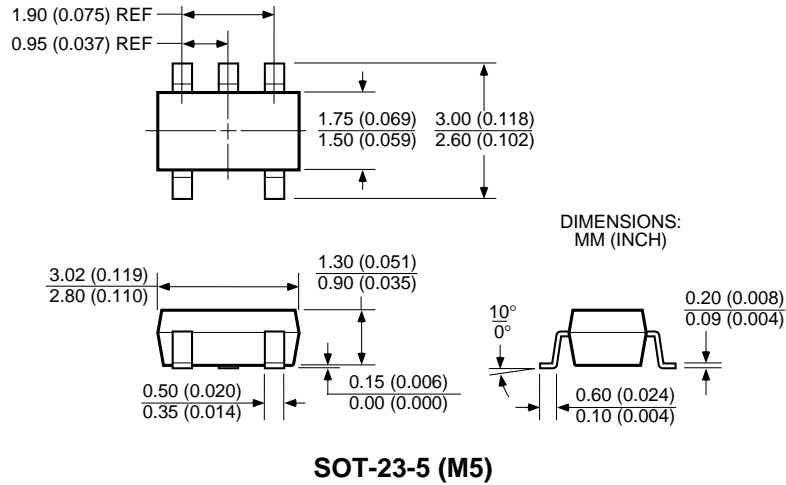
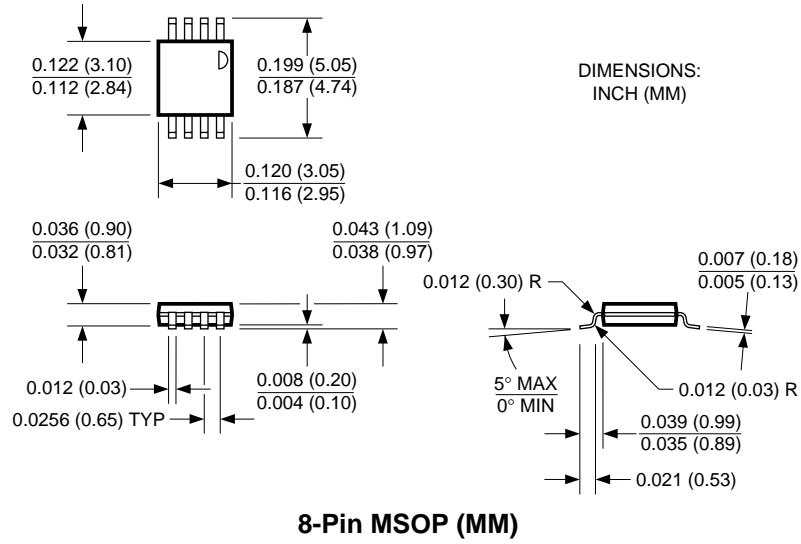

MICREL INC. 1849 FORTUNE DRIVE SAN JOSE, CA 95131 USA

TEL + 1 (408) 944-0800 FAX + 1 (408) 944-0970 WEB <http://www.micrel.com>

This information is believed to be accurate and reliable, however no responsibility is assumed by Micrel for its use nor for any infringement of patents or other rights of third parties resulting from its use. No license is granted by implication or otherwise under any patent or patent right of Micrel Inc.

© 2000 Micrel Incorporated