

DATA SHEET

VER:

PAGE: 1

PRODUCT DESCRIPTION

Standard atmospheric conditions

Unless otherwise specified. The standard range of atmospheric conditions for making measurement and tests are as follow:

Ambient temperature $25\pm 2^{\circ}\text{C}$
Relative humidity $40\%\sim 70\%$

If there is no doubt the results, measurement shall be made within the following limits:

Ambient temperature $25\pm 2^{\circ}\text{C}$
Relative humidity : $40\%\sim 70\%$

Measure equipment

Electrical characteristics measured by S&A250B or equivalent.

Crystal cutting type

The crystal is using AT CUT (thickness shear mode)

ELECTRICAL SPECIFICATIONS

	Parameters	Symbol	Electrical Spec.	UNITS	Notes
1	Nominal Frequency	FL	$35.001\sim 48.000$	MHz	-
2	Oscillation Mode	-	Fund	-	-
3	Load Capacitance	CL	10(STD)	p F	user spec
4	Frequency Tolerance	-	± 20	ppm	at $25\pm 2^{\circ}\text{C}$
5	Operating Temperature	-	$-20\sim +70^{\circ}\text{C}$	$^{\circ}\text{C}$	-
6	Frequency Stability (reference 25°C)	-	± 20	ppm	$-20\sim +70^{\circ}\text{C}$
7	Drive Level	DL	100.0	u W	MAX 350 uW
8	Effective Resistance Rr	ESR	< 40.0	ohm	-
9	Shunt Capaitance C0	C0	< 3.0	p F	-
10	Insulation Resistance	IR	> 500	M-ohm	at DC 100V
11	Aging	-	± 2	ppm	1st Year
12	Reflow shift	-	± 5	ppm	at $265\pm 2^{\circ}\text{C} * 10\text{sec}$
13	Storage Temperature Range	-	$-40\sim +85^{\circ}\text{C}$	$^{\circ}\text{C}$	-
14	ESD	-	HBM $> 2000\text{V}$	$^{\circ}\text{C}$	JESD22-A114-B
15	Others	-	-	-	-

DATA SHEET

VER:

PAGE: 2

DIMENSIONS

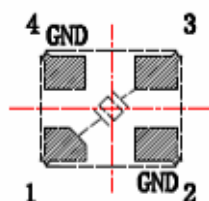
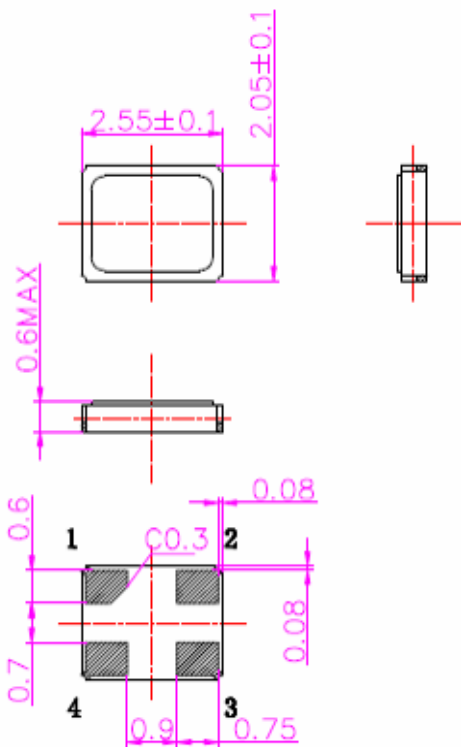

Recommended land pattern

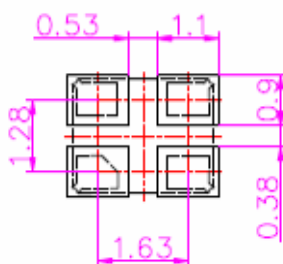

DIMENSIONS
(Unit: mm)

SUGGESTED REFLOW PROFILE

Total time : 360 sec. Max.

Solder melting point : 185°C

