



AK 370/.. - 5.0 - V - GREEN

2-12 poles, Spacing 5,0 mm
insert required no. of poles ..

How to order see page 11

Ratings:

		
Rated Voltage	300 V	250 V
Rated Current	16 A	24 A (T60)
Wire Size	AWG 22-12	2,5 mm ²
Test Voltage		2,0 kV
Rated Torque / Screw Size		0,5 Nm/M3

Max. Rated Cross Section

Single Wired (solid)	2,5 mm ²
Stranded Wire (flexible)	1,5 mm ²
Stranded wire with Ferrules	1,5 mm ²

Dimensions

Spacing	5,0 mm
PCB Hole Diameter	1,3 mm
Stripped Length	6,0 mm

Materials

Insulating Material	PA
Flammability Class	UL94 V-0
Temperature Range	-30°C/+105°C
Terminal Block	CuZn
Wire Guard	Cu
Colour	green
	RAL 6018

AK 370 VERTICAL

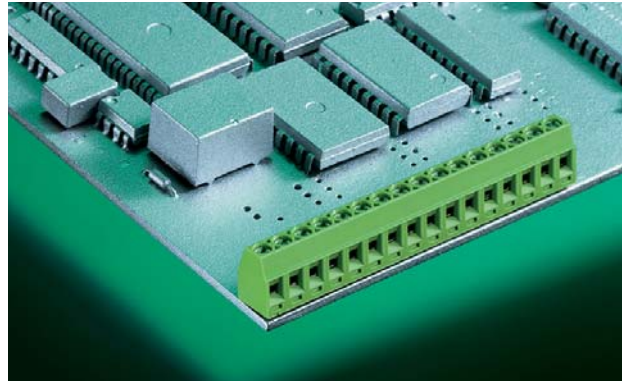
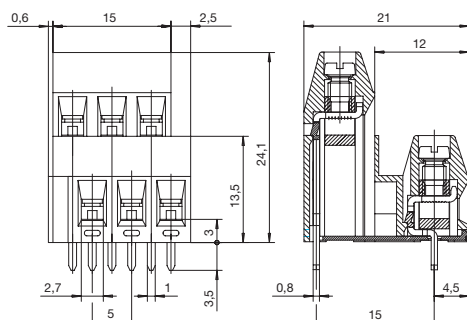



AKZ 602/.. - 3.81 - V - GREEN

2-16 poles, Spacing 3,81 mm
insert required no. of poles ..

How to order see page 11

Press-in technics on request

Ratings:

		
Rated Voltage	300 V	130 V
Rated Current	10 A	13,5 A (T60)
Wire Size	AWG 30-16	1,0 mm ²
Test Voltage		1,25 kV
Rated Torque / Screw Size		0,4 Nm/M2

Max. Rated Cross Section

Single Wired (solid)	1,5 mm ²
Stranded Wire (flexible)	1,0 mm ²
Stranded wire with Ferrules	0,5 mm ²

Dimensions

Spacing	3,81 mm
PCB Hole Diameter	1,1 mm
Stripped Length	5,0 mm

Materials

Insulating Material	PA
Flammability Class	UL94 V-0
Temperature Range	-30°C/+105°C
Terminal Block	CuZn
Wire Guard	Cu
Colour	green
	RAL 6018

AKZ 602

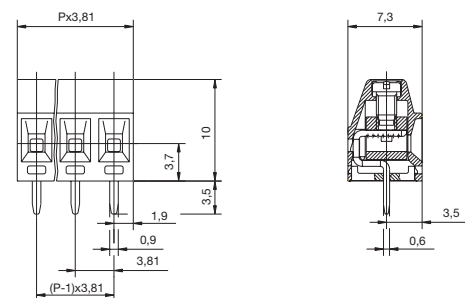

P = No. of poles