

# **XBee®/XBee-PRO® DigiMesh™ 2.4 OEM RF Modules**

---

XBee® DigiMesh 2.4 OEM RF Modules

RF Module Operation

RF Module Configuration



## **OEM RF Modules by Digi International**

### **Firmware version:**

8x0x XBee DigiMesh 2.4



Digi International Inc.  
11001 Bren Road East  
Minnetonka, MN 55343  
877 912-3444 or 952 912-3444  
<http://www.digi.com>

90000991\_A  
9/12/2008

**© 2008 Digi International, Inc. All rights reserved**

No part of the contents of this manual may be transmitted or reproduced in any form or by any means without the written permission of Digi International, Inc.

XBee®/XBee-PRO® and DigiMesh are trademarks or registered trademarks of Digi International, Inc.

**Technical Support:**

Phone: (801) 765-9885

Live Chat: [www.digi.com](http://www.digi.com)

Online support: <http://www.digi.com/support/eservice/eservicelogin.jsp>

# Contents

## **1. XBee/XBee-PRO DigiMesh 2.4 OEM RF Modules 4**

### **Key Features 4 Worldwide Acceptance 4**

### **Specifications 5**

### **Mechanical Drawings 6**

### **Mounting Considerations 6**

### **Pin Signals 7**

### **Electrical Characteristics 8**

## **2. RF Module Operation 9**

### **Serial Communications 9**

UART Data Flow 9

Serial Buffers 9

Serial Flow Control 10

API Operation 11

### **Modes of Operation 12**

Idle Mode 12

Transmit Mode 12

Receive Mode 12

Command Mode 13

## **3. XBee/XBee-PRO® DigiMesh 2.4 14**

### **DigiMesh Networking 14**

### **DigiMesh Feature Set 14**

### **Data Transmission and Routing 14**

Unicast Addressing 14

Broadcast Addressing 14

Routing 15

Route Discovery 15

Sleeping Routers 15

Operation 16

## **4. DigiMesh 2.4 Command Reference Tables 19**

### **API Operation 24**

API Frame Specifications 24

API Frames 25

## **Appendix A: Definitions 34**

## **Appendix B: Agency Certifications 35**

### **United States (FCC) 35**

OEM Labeling Requirements 35

FCC Notices 35

FCC-Approved Antennas (2.4 GHz) 35

### **Europe (ETSI) 38**

OEM Labeling Requirements 38

Restrictions 38

Declarations of Conformity 38

Approved Antennas 39

## **Canada (IC) 39**

Labeling Requirements 39

## **Japan 39**

Labeling Requirements 39

# 1.XBee/XBee-PRO DigiMesh 2.4 OEM RF Modules

The XBee/XBee-PRO DigiMesh 2.4 OEM RF Modules were engineered to support the unique needs of low-cost, low-power wireless sensor networks. The modules require minimal power and provide reliable delivery of data between remote devices.

## Key Features

### Long-range Data Integrity

#### XBee

- Indoor/Urban: up to 100' (30 m)
- Outdoor line-of-sight: up to 300' (100m)
- Transmit Power: 1 mW (0dBm)
- Receiver Sensitivity: -92 dBm

#### XBee-PRO

- Indoor/Urban: up to 300' (90 m)
- Outdoor line-of-sight: up to 1 mile (1600m)
- Transmit Power: 63mW (18dBm) EIRP
- Receiver Sensitivity: -100 dBm (1% packet error rate)
- RF Data Rate: 250,000 bps

### Advanced Networking & Security

- Retries and Acknowledgements
- Self-routing, self-healing mesh networking
- DSSS (Direct Sequence Spread Spectrum)

### Low Power

#### XBee

- TX Peak Current: 45mA
- RX Current: 50mA
- Sleep Current: <50uA

#### XBee-PRO

- TX Peak Current: 250mA (150mA for international variant)
- TX Peak Current (RPSMA module only): 340mA (180mA for international variant)
- RX Current: 55mA
- Sleep Current: <50uA

### Easy-to-Use

- No configuration necessary for out-of box RF communications
- AT and API Command Modes for configuring module parameters
- Small form factor
- Extensive command set
- Free X-CTU Software (Testing and configuration software)

## Worldwide Acceptance

**FCC Approval** (USA) Refer to Appendix A [p63] for FCC Requirements.

Systems that contain XBee®/XBee-PRO RF Modules inherit Digi Certifications.

ISM (Industrial, Scientific & Medical) **2.4 GHz frequency band**

Manufactured under **ISO 9001:2000** registered standards

XBee®/XBee-PRO RF Modules are optimized for use in the United States, Canada, Australia, Israel, Japan, and Europe. Contact Digi for complete list of government agency approvals.



## Specifications

Specifications of the XBee/XBee-PRO DigiMesh 2.4 OEM RF Modules

Specification	XBee	XBee-PRO
<b>Performance</b>		
Indoor/Urban Range	Up to 100 ft (30 m)	Up to 300 ft. (90 m), up to 200 ft (60 m) International variant
Outdoor RF line-of-sight Range	Up to 300 ft (90 m)	Up to 1 mile (1600 m), up to 2500 ft (750 m) international variant
Transmit Power Output (software selectable)	1mW (0 dBm)	63mW (18dBm)* 10mW (10 dBm) for International variant
RF Data Rate	250,000 bps	250,000 bps
Serial Interface Data Rate (software selectable)	1200 bps - 250 kbps (non-standard baud rates also supported)	1200 bps - 250 kbps (non-standard baud rates also supported)
Receiver Sensitivity	-92 dBm (1% packet error rate)	-100 dBm (1% packet error rate)
<b>Power Requirements</b>		
Supply Voltage	2.8 – 3.4 V	2.8 – 3.4 V
Transmit Current (peak)	45mA (@ 3.3 V)	250mA (@3.3 V) (150mA for international variant) RPSMA module only: 340mA (@3.3 V) (180mA for international variant)
Idle / Receive Current (typical)	50mA (@ 3.3 V)	55mA (@ 3.3 V)
Power-down Current	< 50 $\mu$ A	< 50 $\mu$ A
<b>General</b>		
Operating Frequency	ISM 2.4 GHz	ISM 2.4 GHz
Dimensions	0.960" x 1.087" (2.438cm x 2.761cm)	0.960" x 1.297" (2.438cm x 3.294cm)
Operating Temperature	-40 to 85° C (industrial)	-40 to 85° C (industrial)
Antenna Options	Integrated whip, Chip, U.FI Connector, RPSMA Connector	Integrated whip, Chip, U.FI Connector, RPSMA Connector
<b>Networking &amp; Security</b>		
Supported Network Topologies	Point-to-point, Point-to-multipoint & Peer-to-peer	
Number of Channels (software selectable)	16 Direct Sequence Channels	12 Direct Sequence Channels
Addressing Options	PAN ID, Channel and Addresses	PAN ID, Channel and Addresses
<b>Agency Approvals</b>		
United States (FCC Part 15.247)	OUR-XBEE	OUR-XBEEPRO
Industry Canada (IC)	4214A XBEE	4214A XBEEPRO
Europe (CE)	ETSI	ETSI (Max. 10 dBm transmit power output)*
Japan	R201WW07215214	R201WW08215111 (Max. 10 dBm transmit power output)**
Australia	C-Tick	C-Tick

\*When operating in Europe, XBee-PRO DigiMesh 2.4 modules must operate at or below a transmit power output level of 10dBm. Customers have two choices for transmitting at or below 10dBm:

- Order the standard XBee-PRO module and change the PL command to "0" (10dBm).
- Order the International variant of the XBee-PRO module, which has a maximum transmit output power of 10dBm (@ PL=4). Additionally, European regulations stipulate an EIRP power maximum of 12.86 dBm (19 mW) for the XBee-PRO and 12.11 dBm for the XBee when integrating antennas.

\*\*When operating in Japan, only the International variant of the XBee-PRO DigiMesh 2.4 module is approved for use.

## Mechanical Drawings

Antenna Options: The ranges specified are typical when using the integrated Whip (1.5 dBi) and Dipole (2.1 dBi) antennas. The Chip antenna option provides advantages in its form factor; however, it typically yields shorter range than the Whip and Dipole antenna options when transmitting outdoors. For more information, refer to the "XBee Antennas" Knowledgebase Article located on Digi's Support Web site

### Mechanical drawings of the XBee/XBee-PRO DigiMesh 2.4 OEM RF Modules

The XBee and XBee-PRO RF Modules are pin-for-pin compatible.

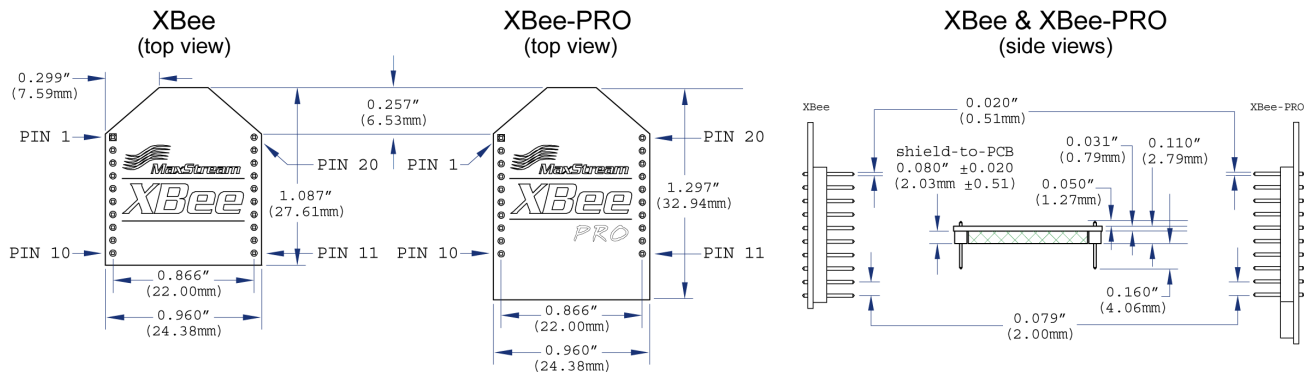

## Mounting Considerations

The XBee/XBee-Pro DigiMesh 2.4 RF Module (through-hole) was designed to mount into a receptacle (socket) and therefore does not require any soldering when mounting it to a board. The Development Kits contain RS-232 and USB interface boards which use two 20-pin receptacles to receive modules.

### XBee/XBee-Pro DigiMesh 2.4 Module Mounting to an RS-232 Interface Board.

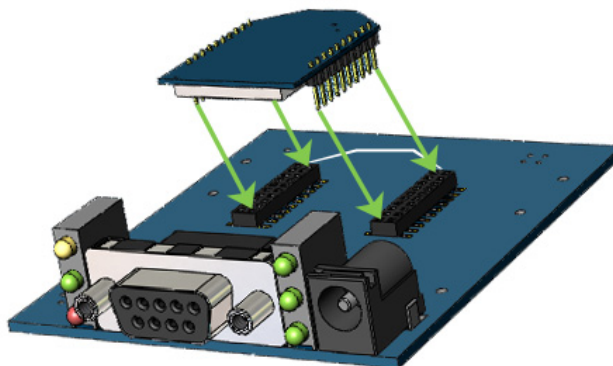

The receptacles used on Digi development boards are manufactured by Century Interconnect. Several other manufacturers provide comparable mounting solutions; however, Digi currently uses the following receptacles:

- Through-hole single-row receptacles - Samtec P/N: MMS-110-01-L-SV (or equivalent)
- Surface-mount double-row receptacles - Century Interconnect P/N: CPRMSL20-D-0-1 (or equivalent)
- Surface-mount single-row receptacles - Samtec P/N: SMM-110-02-SM-S

Digi also recommends printing an outline of the module on the board to indicate the orientation the module should be mounted.

## Pin Signals

### XBee/XBee-PRO DigiMesh 2.4 RF Module Pin Numbers

(top sides shown - shields on bottom)

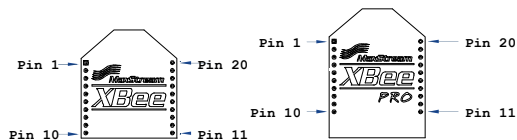

**Table 3-01. Pin Assignments for the XBee/XBee-PRO 2.4 DigiMesh Modules**  
(Low-asserted signals are distinguished with a horizontal line above signal name.)

Pin #	Name	Direction	Description
1	VCC	-	Power supply
2	DOUT	Output	UART Data Out
3	DIN / <u>CONFIG</u>	Input	UART Data In
4	DO8*	Output	Digital Output 8
5	<u>RESET</u>	Input	Module Reset (reset pulse must be at least 200 ns)
6	PWM0 / RSSI	Output	PWM Output 0 / RX Signal Strength Indicator
7	PWM1	Output	PWM Output 1
8	[reserved]	-	Do not connect
9	<u>DTR</u> / SLEEP_RQ / DI8	Input	Pin Sleep Control Line or Digital Input 8
10	GND	-	Ground
11	AD4 / DIO4	Either	Analog Input 4 or Digital I/O 4
12	<u>CTS</u> / DIO7	Either	Clear-to-Send Flow Control or Digital I/O 7
13	ON / <u>SLEEP</u>	Output	Module Status Indicator
14	VREF	Input	Voltage Reference for A/D Inputs
15	Associate / AD5 / DIO5	Either	Associated Indicator, Analog Input 5 or Digital I/O 5
16	<u>RTS</u> / AD6 / DIO6	Either	Request-to-Send Flow Control, Analog Input 6 or Digital I/O 6
17	AD3 / DIO3	Either	Analog Input 3 or Digital I/O 3
18	AD2 / DIO2	Either	Analog Input 2 or Digital I/O 2
19	AD1 / DIO1	Either	Analog Input 1 or Digital I/O 1
20	AD0 / DIO0	Either	Analog Input 0 or Digital I/O 0

\* Function is not supported at the time of this release

#### Design Notes:

- Minimum connections: VCC, GND, DOUT & DIN
- Minimum connections for updating firmware: VCC, GND, DIN, DOUT, RTS & DTR
- Signal Direction is specified with respect to the module
- Module includes a 50k  $\Omega$  pull-up resistor attached to RESET
- Several of the input pull-ups can be configured using the PR command
- Unused pins should be left disconnected

## Electrical Characteristics

**Table 3-02. DC Characteristics (VCC = 2.8 - 3.4 VDC)**

Symbol	Characteristic	Condition	Min	Typical	Max	Unit
V <sub>IL</sub>	Input Low Voltage	All Digital Inputs	-	-	0.35 * VCC	V
V <sub>IH</sub>	Input High Voltage	All Digital Inputs	0.7 * VCC	-	-	V
V <sub>OL</sub>	Output Low Voltage	I <sub>OL</sub> = 2 mA, VCC >= 2.7 V	-	-	0.5	V
V <sub>OH</sub>	Output High Voltage	I <sub>OH</sub> = -2 mA, VCC >= 2.7 V	VCC - 0.5	-	-	V
I <sub>IIN</sub>	Input Leakage Current	V <sub>IN</sub> = VCC or GND, all inputs, per pin	-	0.025	1	μA
I <sub>IOZ</sub>	High Impedance Leakage Current	V <sub>IN</sub> = VCC or GND, all I/O High-Z, per pin	-	0.025	1	μA
TX	Transmit Current	VCC = 3.3 V	-	45 (XBee) 215, 140 (PRO, Int)	-	mA
RX	Receive Current	VCC = 3.3 V	-	50 (XBee) 55 (PRO)	-	mA
PWR-DWN	Power-down Current	SM parameter = 1	-	< 10	-	μA

**Table 3-03. ADC Characteristics (Operating)**

Symbol	Characteristic	Condition	Min	Typical	Max	Unit
V <sub>REFH</sub>	VREF - Analog-to-Digital converter reference range		2.08	-	V <sub>DDAD</sub>	V
I <sub>REF</sub>	VREF - Reference Supply Current	Enabled	-	200	-	μA
		Disabled or Sleep Mode	-	< 0.01	0.02	μA
V <sub>INDC</sub>	Analog Input Voltage <sup>1</sup>		V <sub>SSAD</sub> - 0.3	-	V <sub>DDAD</sub> + 0.3	V

1. Maximum electrical operating range, not valid conversion range.

**Table 3-04. ADC Timing/Performance Characteristics<sup>1</sup>**

Symbol	Characteristic	Condition	Min	Typical	Max	Unit
R <sub>AS</sub>	Source Impedance at Input <sup>2</sup>		-	-	10	kΩ
V <sub>AIN</sub>	Analog Input Voltage <sup>3</sup>		V <sub>REFL</sub>		V <sub>REFH</sub>	V
RES	Ideal Resolution (1 LSB) <sup>4</sup>	2.08V ≤ V <sub>DDAD</sub> ≤ 3.6V	2.031	-	3.516	mV
DNL	Differential Non-linearity <sup>5</sup>		-	±0.5	±1.0	LSB
INL	Integral Non-linearity <sup>6</sup>		-	±0.5	±1.0	LSB
E <sub>ZS</sub>	Zero-scale Error <sup>7</sup>		-	±0.4	±1.0	LSB
F <sub>FS</sub>	Full-scale Error <sup>8</sup>		-	±0.4	±1.0	LSB
E <sub>IL</sub>	Input Leakage Error <sup>9</sup>		-	±0.05	±5.0	LSB
E <sub>TU</sub>	Total Unadjusted Error <sup>10</sup>		-	±1.1	±2.5	LSB

1. All ACCURACY numbers are based on processor and system being in WAIT state (very little activity and no IO switching) and that adequate low-pass filtering is present on analog input pins (filter with 0.01 μF to 0.1 μF capacitor between analog input and VREFL). Failure to observe these guidelines may result in system or microcontroller noise causing accuracy errors which will vary based on board layout and the type and magnitude of the activity.

Data transmission and reception during data conversion may cause some degradation of these specifications, depending on the number and timing of packets. It is advisable to test the ADCs in your installation if best accuracy is required.

2. R<sub>AS</sub> is the real portion of the impedance of the network driving the analog input pin. Values greater than this amount may not fully charge the input circuitry of the ATD resulting in accuracy error.

3. Analog input must be between V<sub>REFL</sub> and V<sub>REFH</sub> for valid conversion. Values greater than V<sub>REFH</sub> will convert to \$3FF.

4. The resolution is the ideal step size or 1LSB = (V<sub>REFH</sub> - V<sub>REFL</sub>) / 1024

5. Differential non-linearity is the difference between the current code width and the ideal code width (1LSB). The current code width is the difference in the transition voltages to and from the current code.

6. Integral non-linearity is the difference between the transition voltage to the current code and the adjusted ideal transition voltage for the current code. The adjusted ideal transition voltage is (Current Code - 1/2) \* (1 / ((V<sub>REFH</sub> + E<sub>FS</sub>) - (V<sub>REFL</sub> + E<sub>ZS</sub>))).

7. Zero-scale error is the difference between the transition to the first valid code and the ideal transition to that code. The Ideal transition voltage to a given code is (Code - 1/2) \* (1 / (V<sub>REFH</sub> - V<sub>REFL</sub>)).

8. Full-scale error is the difference between the transition to the last valid code and the ideal transition to that code. The ideal transition voltage to a given code is (Code - 1/2) \* (1 / (V<sub>REFH</sub> - V<sub>REFL</sub>)).

9. Input leakage error is error due to input leakage across the real portion of the impedance of the network driving the analog pin. Reducing the impedance of the network reduces this error.

10. Total unadjusted error is the difference between the transition voltage to the current code and the ideal straight-line transfer function. This measure of error includes inherent quantization error (1/2LSB) and circuit error (differential, integral, zero-scale, and full-scale) error. The specified value of E<sub>TU</sub> assumes zero E<sub>IL</sub> (no leakage or zero real source impedance).



# 2. RF Module Operation

## Serial Communications

The XBee/XBee-PRO 2.4 DigiMesh OEM RF Modules interface to a host device through a logic-level asynchronous serial port. Through its serial port, the module can communicate with any logic and voltage compatible UART; or through a level translator to any serial device (For example: Through a Digi proprietary RS-232 or USB interface board).

### UART Data Flow

Devices that have a UART interface can connect directly to the pins of the RF module as shown in the figure below.

#### System Data Flow Diagram in a UART-interfaced environment

(Low-asserted signals distinguished with horizontal line over signal name.)

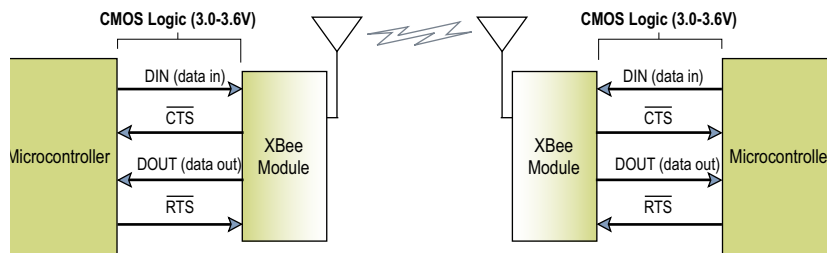

### Serial Data

Data enters the module UART through the DIN (pin 3) as an asynchronous serial signal. The signal should idle high when no data is being transmitted.

Each data byte consists of a start bit (low), 8 data bits (least significant bit first) and a stop bit (high). The following figure illustrates the serial bit pattern of data passing through the module.

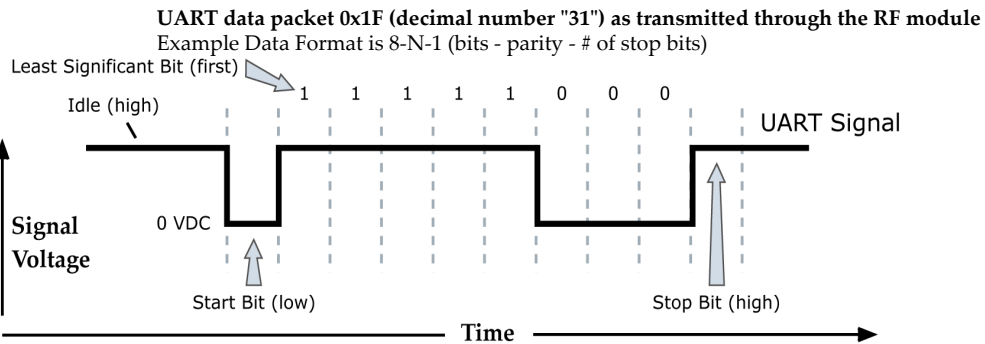

The module UART performs tasks, such as timing and parity checking, that are needed for data communications. Serial communications depend on the two UARTs to be configured with compatible settings (baud rate, parity, start bits, stop bits, data bits).

### Serial Buffers

The XBee-PRO modules maintain buffers to collect received serial and RF data, which is illustrated in the figure below. The serial receive buffer collects incoming serial characters and holds them until they can be processed. The serial transmit buffer collects data that is received via the RF link that will be transmitted out the UART.

Internal Data Flow Diagram

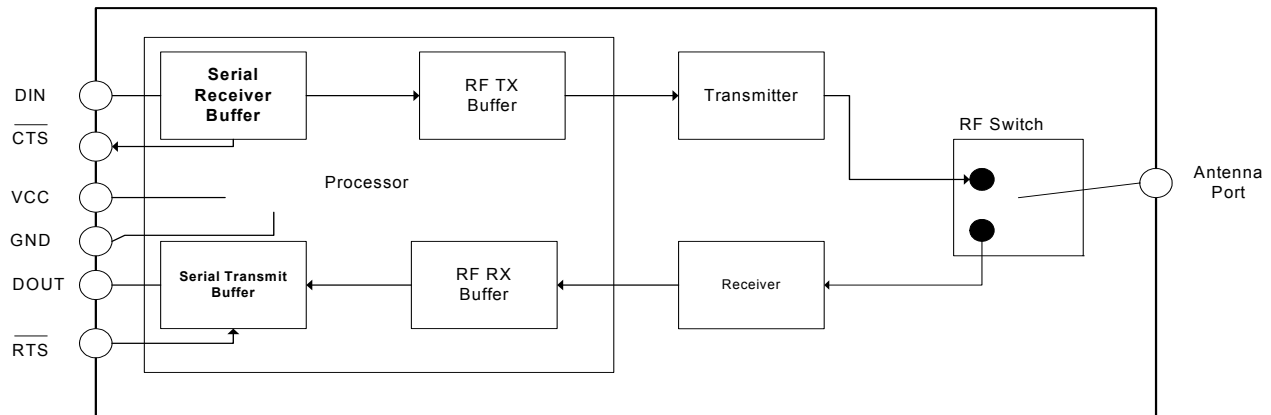

### Serial Receive Buffer

When serial data enters the RF module through the DIN Pin (pin 3), the data is stored in the serial receive buffer until it can be processed. Under certain conditions, the module may not be able to process data in the serial receive buffer immediately. If large amounts of serial data are sent to the module, CTS flow control may be required to avoid overflowing the serial receive buffer.

#### Cases in which the serial receive buffer may become full and possibly overflow:

1. If the module is receiving a continuous stream of RF data, the data in the serial receive buffer will not be transmitted until the module is no longer receiving RF data.
2. If the module is transmitting an RF data packet, the module may need to discover the destination address or establish a route to the destination. After transmitting the data, the module may need to retransmit the data if an acknowledgment is not received, or if the transmission is a broadcast. These issues could delay the processing of data in the serial receive buffer.

### Serial Transmit Buffer

When RF data is received, the data is moved into the serial transmit buffer and is sent out the serial port. If the serial transmit buffer becomes full enough such that all data in a received RF packet won't fit in the serial transmit buffer, the entire RF data packet is dropped.

#### Cases in which the serial transmit buffer may become full resulting in dropped RF packets

If the RF data rate is set higher than the interface data rate of the module, the module could receive data faster than it can send the data to the host.

If the host does not allow the module to transmit data out from the serial transmit buffer because of being held off by hardware flow control.

### Serial Flow Control

The  $\overline{\text{RTS}}$  and  $\overline{\text{CTS}}$  module pins can be used to provide  $\overline{\text{RTS}}$  and/or  $\overline{\text{CTS}}$  flow control.  $\overline{\text{CTS}}$  flow control provides an indication to the host to stop sending serial data to the module.  $\overline{\text{RTS}}$  flow control allows the host to signal the module to not send data in the serial transmit buffer out the UART.  $\overline{\text{RTS}}$  and  $\overline{\text{CTS}}$  flow control are enabled using the D6 and D7 commands.

#### $\overline{\text{CTS}}$ Flow Control

If  $\overline{\text{CTS}}$  flow control is enabled (D7 command), when the serial receive buffer is filled with FT bytes, the module de-asserts  $\overline{\text{CTS}}$  (sets it high) to signal to the host device to stop sending serial data.  $\overline{\text{CTS}}$  is re-asserted when less than FT - 16 bytes are in the UART receive buffer.

### **RTS Flow Control**

---

If flow  $\overline{\text{RTS}}$  control is enabled ( $\overline{\text{D6}}$  command), data in the serial transmit buffer will not be sent out the DOUT pin as long as  $\overline{\text{RTS}}$  is de-asserted (set high). The host device should not de-assert  $\overline{\text{RTS}}$  for long periods of time to avoid filling the serial transmit buffer. If an RF data packet is received, and the serial transmit buffer does not have enough space for all of the data bytes, the entire RF data packet will be discarded.

### **Transparent Operation**

---

When operating in Transparent Operation, the modules act as a serial line replacement. All UART data received through the DIN pin is queued up for RF transmission. When RF data is received, the data is sent out the DOUT pin. The module configuration parameters are configured using the AT command mode interface. (See RF Module Operation --> Command Mode.)

### **Serial-to-RF Packetization**

---

Data is buffered in the serial receive buffer until one of the following causes the data to be packetized and transmitted:

No serial characters are received for the amount of time determined by the RO (Packetization Timeout) parameter. If RO = 0, packetization begins when a character is received.

The maximum number of characters that will fit (73) in an RF packet is received.

The Command Mode Sequence (GT + CC + GT) is received. Any character buffered in the serial receive buffer before the sequence is transmitted.

## **API Operation**

---

API (Application Programming Interface) Operation is an alternative to the default Transparent Operation. The frame-based API extends the level to which a host application can interact with the networking capabilities of the module. When in API mode, all data entering and leaving the module is contained in frames that define operations or events within the module.

Transmit Data Frames (received through the DIN pin (pin 3)) include:

- RF Transmit Data Frame
- Command Frame (equivalent to AT commands)

Receive Data Frames (sent out the DOUT pin (pin 2)) include:

- RF-received data frame
- Command response
- Event notifications such as reset, etc.

The API provides alternative means of configuring modules and routing data at the host application layer. A host application can send data frames to the module that contain address and payload information instead of using command mode to modify addresses. The module will send data frames to the application containing status packets; as well as source, and payload information from received data packets.

The API operation option facilitates many operations such as the examples cited below:

-> Transmitting data to multiple destinations without entering Command Mode

-> Receive success/failure status of each transmitted RF packet

-> Identify the source address of each received packet

---

To implement API operations, refer to the API Operation chapter 6.

---

## Modes of Operation

### Idle Mode

When not receiving or transmitting data, the RF module is in Idle Mode. During Idle Mode, the RF module is also checking for valid RF data. The module shifts into the other modes of operation under the following conditions:

- Transmit Mode (Serial data in the serial receive buffer is ready to be packetized)
- Receive Mode (Valid RF data is received through the antenna)
- Command Mode (Command Mode Sequence is issued)

### Transmit Mode

When serial data is received and is ready for packetization, the RF module will exit Idle Mode and attempt to transmit the data. The destination address determines which node(s) will receive the data.

If a route is not known, route discovery will take place for the purpose of establishing a route to the destination node. If a module with a matching network address is not discovered, the packet is discarded. The data will be transmitted once a route is established. If route discovery fails to establish a route, the packet will be discarded.

#### Transmit Mode Sequence

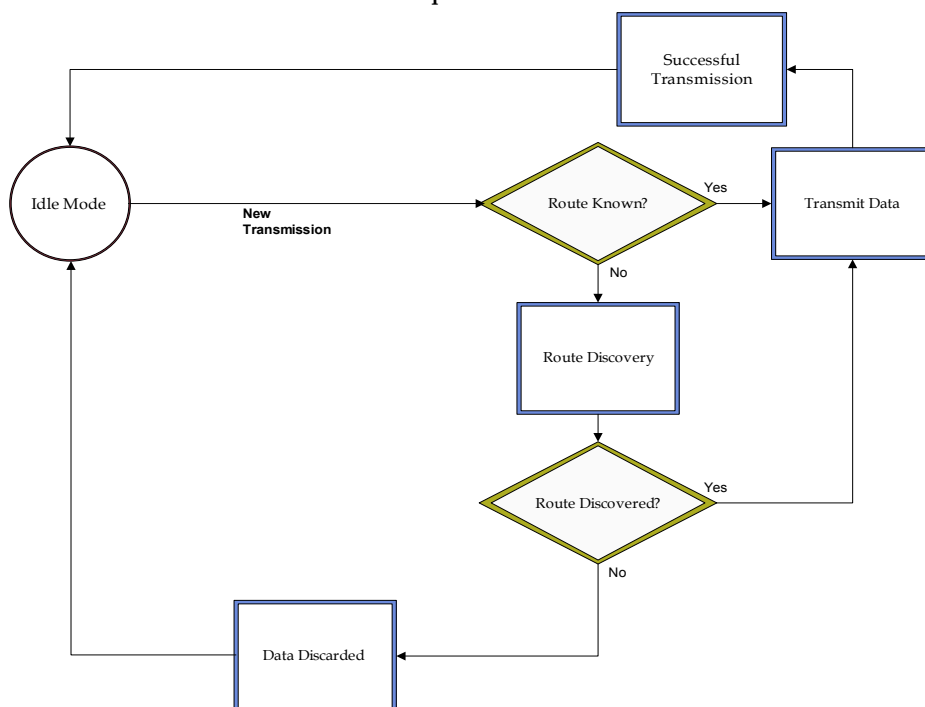

When data is transmitted from one node to another, a network-level acknowledgement is transmitted back across the established route to the source node. This acknowledgement packet indicates to the source node that the data packet was received by the destination node. If a network acknowledgement is not received, the source node will re-transmit the data. See Data Transmission and Routing in chapter 3 for more information.

### Receive Mode

If a valid RF packet is received, the data is transferred to the serial transmit buffer

## Command Mode

To modify or read RF Module parameters, the module must first enter into Command Mode - a state in which incoming serial characters are interpreted as commands. Refer to the API Mode section for an alternate means of configuring modules.

### AT Command Mode

#### To Enter AT Command Mode:

Send the 3-character command sequence "+++" and observe guard times before and after the command characters. [Refer to the "Default AT Command Mode Sequence" below.]

Default AT Command Mode Sequence (for transition to Command Mode):

- No characters sent for one second [GT (Guard Times) parameter = 0x3E8]
- Input three plus characters ("+++") within one second [CC (Command Sequence Character) parameter = 0x2B.]
- No characters sent for one second [GT (Guard Times) parameter = 0x3E8]

All of the parameter values in the sequence can be modified to reflect user preferences.

NOTE: Failure to enter AT Command Mode is most commonly due to baud rate mismatch. Ensure the 'Baud' setting on the "PC Settings" tab matches the interface data rate of the RF module. By default, the BD parameter = 3 (9600 bps).

#### To Send AT Commands:

Send AT commands and parameters using the syntax shown below.

Syntax for sending AT Commands

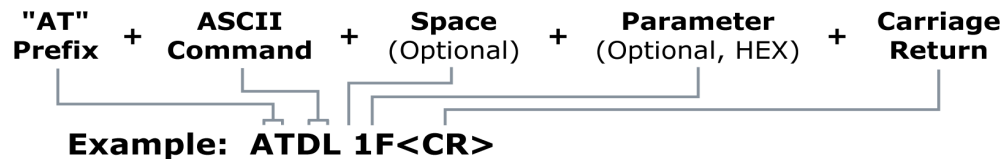

To read a parameter value stored in the RF module's register, omit the parameter field.

The preceding example would change the RF module Destination Address (Low) to "0x1F". To store the new value to non-volatile (long term) memory, subsequently send the WR (Write) command.

For modified parameter values to persist in the module's registry after a reset, changes must be saved to non-volatile memory using the WR (Write) Command. Otherwise, parameters are restored to previously saved values after the module is reset.

**System Response.** When a command is sent to the module, the module will parse and execute the command. Upon successful execution of a command, the module returns an "OK" message. If execution of a command results in an error, the module returns an "ERROR" message.

#### To Exit AT Command Mode:

1. Send the ATCN (Exit Command Mode) command (followed by a carriage return).  
[OR]
2. If no valid AT Commands are received within the time specified by CT (Command Mode Timeout) Command, the RF module automatically returns to Idle Mode.

For an example of programming the RF module using AT Commands and descriptions of each configurable parameter, refer to the "Command Reference Tables" chapter.

### Sleep Mode

Sleep mode allows the module to enter a low power state. See chapter 3 for more information.

# 3. XBee/XBee-PRO® DigiMesh 2.4

---

## DigiMesh Networking

---

Mesh networking allows messages to be routed through several different nodes to a final destination. DigiMesh firmware allows OEMs and system integrators to bolster their networks with the self-healing attributes of mesh networking. In the event that one RF connection between nodes is lost (due to power-loss, environmental obstructions, etc.) critical data can still reach its destination due to the mesh networking capabilities embedded inside the modules.

## DigiMesh Feature Set

---

DigiMesh contains the following features

- **Self-healing**  
Any node may enter or leave the network at any time without causing the network as a whole to fail.
- **Peer-to-peer architecture**  
No hierarchy and no parent-child relationships are needed.
- **Quiet Protocol**  
Routing overhead will be reduced by using a reactive protocol similar to AODV.
- **Route Discovery**  
Rather than maintaining a network map, routes will be discovered and created only when needed.
- **Selective acknowledgements**  
Only the destination node will reply to route requests.
- **Reliable delivery**  
Reliable delivery of data is accomplished by means of acknowledgements.
- **Sleep Modes**  
Low power sleep modes with synchronized wake are supported, with variable sleep and wake times.

## Data Transmission and Routing

---

### Unicast Addressing

---

When transmitting while using Unicast communications, reliable delivery of data is accomplished using retries and acknowledgements. The number of retries is determined by the NR (Network Retries) parameter. RF data packets are sent up to NR + 1 times and ACKs (acknowledgements) are transmitted by the receiving node upon receipt. If a network ACK is not received within the time it would take for a packet to traverse the network twice, a retransmission occurs.

To send Unicast messages, set the DH and DL on the transmitting module to match the corresponding SH and SL parameter values on the receiving module.

### Broadcast Addressing

---

Broadcast transmissions will be received and repeated by all nodes in the network. Because ACKs are not used the originating node will send the broadcast four times. Essentially the extra transmissions become automatic retries without acknowledgments. This will result in all nodes repeating the transmission four times as well. In order to avoid RF packet collisions, a random delay is inserted before each node relays the broadcast message. (See NN parameter for details on changing this random delay time.) Sending frequent broadcast transmissions can quickly reduce the available network bandwidth and as such should be used sparingly.

## Routing

---

A module within a mesh network is able to determine reliable routes using a routing algorithm and table. The routing algorithm uses a reactive method derived from AODV (Ad-hoc On-demand Distance Vector). An associative routing table is used to map a destination node address with its next hop. By sending a message to the next hop address, either the message will reach its destination or be forwarded to an intermediate node which will route the message on to its destination. A message with a Broadcast address is broadcast to all neighbors. All receiving neighbors will rebroadcast the message and eventually the message will reach all corners of the network. Packet tracking prevents a node from resending a broadcast message twice.

## Route Discovery

---

If the source node doesn't have a route to the requested destination, the packet is queued to await a route discovery (RD) process. This process is also used when a route fails. A route fails when the source node uses up its network retries without ever receiving an ACK. This results in the source node initiating RD.

RD begins by the source node broadcasting a route request (RREQ). Any node that receives the RREQ that is not the ultimate destination is called an intermediate node.

Intermediate nodes may either drop or forward a RREQ, depending on whether the new RREQ has a better route back to the source node. If so, information from the RREQ is saved and the RREQ is updated and broadcast. When the ultimate destination receives the RREQ, it unicasts a route reply (RREP) back to the source node along the path of the RREQ. This is done regardless of route quality and regardless of how many times an RREQ has been seen before.

This allows the source node to receive multiple route replies. The source node selects the route with the best round trip route quality, which it will use for the queued packet and for subsequent packets with the same destination address.

## Sleeping Routers

---

Sleeping routers under DigiMesh allows for all nodes in the network to synchronize their sleep and wake times. All synchronized nodes enter and exit a low power state at the same time. This forms a cyclic sleeping network. Nodes synchronize by receiving a special RF packet called a synch message which is sent by a sleep coordinator. Any node in the network can become a sleep coordinator through a process called nomination. The sleep coordinator will send one synch message at the beginning of each wake period. The synch message being a broadcast packet is repeated by every node in the network.

There are two modes of operation:

SM0 - Normal (default)

SM4 - Cyclic Sleep (low power)

A network should consist of nodes operating in the same mode. Mesh route discovery, and thereby routing, is incompatible between nodes operating in different modes. However, during network setup and maintenance, a mix of nodes is useful, and can be tolerated provided route discovery is not attempted.

## Sleep Mode

---

A node in cyclic sleep mode sleeps for a programmed time, wakes in unison with other nodes, exchanges data and synch messages, and then returns to sleep. While asleep, it cannot receive RF messages, neither will it read commands from the UART port. Sleep and wake times are set by SP and ST respectively. These parameters must be set the same for all nodes in the network. If D7 = 1 (CTS Flow control) CTS is de-asserted while asleep, and asserted while awake.

An unsynched sleeping node, newly powered, will wake and poll for a synch message and then return to sleep, repeating the cycle until it becomes synched by receiving a synch message. Once synched, the node will wake to exchange messages for the programmed time interval and then return to sleep.

## Normal Mode

---

Normal mode is the default mode for a newly powered on node. In this mode a node will not sleep, but will synchronize to a sleeping network. When synchronized a normal node can aid in setting up and maintaining a synchronized network by responding to synch message requests from nodes in cyclic sleep mode (SM4) by sending a special unicast synch message.

**Note:** Although a normal node can synchronize to a sleeping network, it will not defer data transmission during sleep. A normal mode node synchronized to a sleeping network can be used for maintenance purposes such as adding new nodes to the sleeping networks.

## Operation

---

### Nomination

---

Nomination is the process where a node becomes a sleep coordinator at the start of a sleeping network or in the event a sleep coordinator fails as a replacement. This process is automatic with any sleeping node being eligible to become the sleep coordinator for the network. This process can be managed through SO by allowing a node to alter the algorithm used for nomination giving the node a greater chance to become the sleep coordinator. This option is designed for maintenance purposes and is not necessary for cyclic sleep operation.

If the node has the preferred sleep coordinator option-enabled (SO=1), then it will poll during its first cycle for a synch message. If it becomes synched by receiving a synch message, it will cycle back to sleep and will not become the sleep coordinator. If it does not become synched during that first cycle, then it will nominate itself as the sleep coordinator and will start sending synch messages at the start of its second cycle.

Any sleeping node, if it does not receive a message for three cycles, may nominate itself to act as a replacement sleep coordinator. Depending on the platform and other configured options, such a node will eventually nominate itself after a number of cycles without a synch. If preferred sleep coordinator option is enabled, a sleeping node will nominate itself immediately after one cycle without a synch message.

### Election

---

If multiple nodes nominate themselves at the same time, then an election will take place to resolve which node will function as the network's sleep coordinator. A node will disable synching if it receives a synch message from a senior node. A node running in normal mode (with preferred sleep coordinator option enabled) is senior to any node operating in sleep mode. A node with the largest MAC address value is senior to any other node operating in the same mode.

### Preferred Sleep Coordinator Option

---

The preferred sleep coordinator option is

- SO = 1 - preferred sleep coordinator.

Enabling this bit will cause a node operating in normal mode to act as a sleep coordinator or cause a sleeping node to nominate itself after one cycle without receiving a synch message. Setting a normal mode node to act as a sleep coordinator can be used to start a network. After the network is set up the normal node can be turned off if no longer needed. A sleeping node, after several cycles, will elect itself as the sleep coordinator. Designating a cyclic sleep mode node as a preferred sleep coordinator is useful where a node or nodes are conveniently positioned for maintenance. It is also useful when enabled on a centrally located node to minimize the number of hops a synch message must take to get across the network.

### Programming Sleep Time Intervals

---

The commands for programming sleep time intervals are

- SP - sleep time
- ST - wake time.

### Starting a Sleeping Network

---

By default, all new nodes operate in normal mode. To start a sleeping network, follow these steps:



1. Enable the preferred sleep coordinator on one of the nodes, and set its SP and ST to their default values. The idea is to set these values short enough so that commands can be sent quickly throughout the network which will set a longer sleep cycle.
2. Next, power on the other nodes within range of the sleep coordinator.  
The nodes will receive the synch message and synchronize themselves to the short cycle SP and ST.
3. Configure one or more of the nodes with the preferred sleep coordinator option.  
Since they are already synched and in range of the sleep coordinator, they will not nominate themselves.
4. Configure the nodes which do not have the preferred sleep coordinator option enabled with SM4, putting them into cyclic sleep mode.
5. Reconfigure the sleep coordinator to the SP and ST values selected for the deployed network.
6. Wait a cycle for the sleeping nodes to synch themselves to the new SP and ST values.
7. Deploy the sleeping nodes to their positions.
8. Reconfigure the sleep coordinator node with SM4 to operate in sleep node and deploy the node.

### **Maintaining a Network**

---

Use the following tasks to help maintain a network: adding a node--both normal and sleeping, changing sleep parameters, and rejoining subnets operating out of synch.

#### **Adding a Normal Node**

To add a node to an existing network:

Power on the new node and deploy it within range of a node in the network. If there is a sleep coordinator in the network, the new node will pick up the message when it is broadcast. Through the synch message it will become aware of the network's wake and sleep time intervals, and the time the next cycle will begin.

#### **Adding a Sleeping Node**

Adding a sleeping node to an existing network of sleeping nodes is easier if you use a node operating in normal mode as an assist.

1. Set up a normal node in range of another node in the network.
2. Wait a cycle time for the normal node to synch with the network.
3. Configure the sleeping node with the command ATSM4, write the mode to the configuration with ATWR, and reset the node.
4. Place the new sleeping node in range of the normal node. As the sleeping node wakes, it realizes it is unsynched, and will request a synch message. The normal node will then respond with a special unicast synch special unicast synch message. The new sleeping node will adjust its configuration to match the synch message's contents, and a cycle later will wake in synch with the rest of the sleeping network.

### **Changing Sleep Parameters**

Use the following steps to change sleep parameters:

1. Enter the SP command with the sleep time interval represented in units of 10 msec.
2. Enter the ST command with the wake time interval represented in units of 1 msec.
3. Verify the values of the SP and ST commands.

**Note:** the value of the ST configuration parameter will be automatically adjusted to a minimum effective value if the value of SP is increased enough. However, ST will not be automatically adjusted downwards should the value of SP be decreased. Enter the apply changes command AC. At the start of the next cycle, a special overriding synch message will be broadcast across the network. It will override any synch message coming from any sleep coordinator. Then, a cycle later, the network will wake and operate according to the new ST and SP values.

### **Rejoining Subnets**

Mesh networks get their robustness from taking advantage of routing redundancies which may be available in a network. It is recommended to architect the network with redundant mesh nodes to increase robustness. If a scenario exists such that the only route connecting a subnet to the rest of the network depends on a single node, and that node fails--or the wireless link fails due to changing environmental conditions (catastrophic failure condition), then multiple subnets may arise while using the same wake and sleep intervals, but out of phase with each other due to clock drift. The first task is to repair, replace, and strengthen the weak link with new and/or redundant nodes so this problem doesn't arise again. The second task is to get the subnets back in phase (rejoin subnets).

To get the subnets back in phase, follow these steps:

1. Power up a node in normal mode, and position it next to a node in the subnet you want to use as a reference.
2. Wait a cycle (plus a bit more for safety margin) for it to synch with the network.
3. Enable its preferred sleep coordinator option. This node will now become the sleep coordinator for the network. A synch from a normal node overrides synch messages from any sleeping node and will cause any sleep coordinator node to disable its own synch message.

To place each out-of-phase sleeping node, follow these steps:

1. Place the sleep coordinator node in range of the sleeping node and toggle power for the sleeping node off and back on.
2. When the sleeping coordinator node powers up, it sees that it is out of synch, and requests a synch message. The sleep coordinator node will receive the request and transmit a special unicast synch response. The sleeping node will return to sleep and wake again in synch with the rest of the network.
3. Power down and store away the normal node for safe keeping.

# 4. DigiMesh 2.4 Command Reference Tables

## Special

### Special Commands

AT Command	Name and Description	Parameter Range	Default
WR	<b>Write.</b> Write parameter values to non-volatile memory so that parameter modifications persist through subsequent resets. Note: Once WR is issued, no additional characters should be sent to the module until after the "OK\r" response is received.	--	--
RE	<b>Restore Defaults.</b> Restore module parameters to factory defaults.	--	--
FR	<b>Software Reset.</b> Reset module. Responds immediately with an "OK" then performs a reset 100ms later.	--	--
AC	<b>Apply Changes.</b> Immediately applies new settings without exiting command mode.	--	--
VL	<b>Version Long.</b> Shows detailed version information including application build date and time.	--	--

## Addressing

### Addressing Commands

AT Command	Name and Description	Parameter Range	Default
DH	<b>Destination Address High.</b> Set/Get the upper 32 bits of the 64-bit destination address. When combined with DL, it defines the destination address used for transmission.	0 to 0xFFFFFFFF	0
DL	<b>Destination Address Low.</b> Set/Get the lower 32 bits of the 64-bit destination address. When combined with DH, DL defines the destination address used for transmission.	0 to 0xFFFFFFFF	0x0000FFFF
SH	<b>Serial Number High.</b> Read high 32 bits of the RF module's unique IEEE 64-bit address. 64-bit source address is always enabled. This value is read-only and it never changes	0x-0xFFFFFFFF	Factory
SL	<b>Serial Number Low.</b> Read low 32 bits of the RF module's unique IEEE 64-bit address. 64-bit source address is always enabled. This is read only and it is also the serial number of the node. .	0 to 0xFFFFFFFF	Factory
NI	<b>Node Identifier.</b> Stores a string identifier. The register only accepts printable ASCII data. In AT Command Mode, a string can not start with a space. A carriage return ends the command. Command will automatically end when maximum bytes for the string have been entered. This string is returned as part of the ND (Node Discover) command. This identifier is also used with the DN (Destination Node) command.	20-Byte printable ASCII string	Space Character

## Serial Interfacing (I/O)

### Serial Interfacing Commands

AT Command	Name and Description	Parameter Range	Default
AP	<b>API mode.</b> Set or read the API mode of the radio. The following settings are allowed: 0 API mode is off. All UART input and output is raw data and packets are delineated using the RO parameter. 1 API mode is on. All UART input and output data is packetized in the API format, without escape sequences. 2 API mode is on with escaped sequences inserted to allow for control characters (XON, XOFF, escape, and the 0x7e delimiter to be passed as data.	0, 1, or 2	0
AO	<b>API Output Format.</b> Enables different API output frames. Options include: 0 Standard Data Frames (0x90 for RF rx) 1 Explicit Addressing Data Frames (0x91 for RF rx)	0, 1	0
BD	<b>Baud rate.</b> Set or read serial interface rate (speed for data transfer between radio modem and host). Values from 0-8 select preset standard rates. Values at 0x7A and above select the actual baud rate. Baud rates above 250,00 bps are not supported. The values from 0 to 8 are interpreted as follows: 0 - 1,200bps    3 - 9,600bps    6 - 57,600bps 1 - 2,400bps    4 - 19,200bps    7 - 115,200bps 2 - 4,800bps    5 - 38,400bps    8 - 230,400bps Note that exact baud rates cannot be achieved for 115,200 and 230,400 bps and are 111,111 and 250,000 respectively.	0 to 8, and 0x7a to 0x1C9C38	0x03 (9600 bps)
RO	<b>Packetization Timeout.</b> Set/Read number of character times of inter-character silence required before packetization. Set (RO=0) to transmit characters as they arrive instead of buffering them into one RF packet.	0 - 0xFF [x character times]	3

**Serial Interfacing Commands**

AT Command	Name and Description	Parameter Range	Default
FT	<b>Flow Control Threshold.</b> Set or read flow control threshold. De-assert CTS and/or send XOFF when FT bytes are in the UART receive buffer. Re-assert CTS when less than FT - 16 bytes are in the UART receive buffer.	0x11 to 0xEE	0xbe = 190
NB	<b>Parity.</b> Set or read parity settings for UART communications. The values from 0 to 4 are interpreted as follows: <b>0</b> No parity <b>3</b> Forced high parity <b>1</b> Even parity <b>4</b> Forced low parity <b>2</b> Odd parity	0 to 4	0 (No parity)
D7	<b>DIO7 Configuration.</b> Configure options for the DIO7 line of the module. Options include: 0 = Input, unmonitored 1 = CTS flow control 3 = Digital input, monitored 4 = Digital output low 5 = Digital output high 6 = RS-485 Tx enable, low TX (0V on transmit, high when idle) 7 = RS-485 Tx enable, high TX (high on transmit, 0V when idle)	0-1, 3-7	0
D6	<b>DIO6 Configuration.</b> Configure options for the DIO6 line of the module. Options include: 0 = Input, unmonitored 1 = RTS flow control 3 = Digital input, monitored 4 = Digital output low 5 = Digital output high	0-1, 3-5	0
D5	<b>AD5/DIO5 Configuration.</b> Configure options for the AD5/DIO5 line of the module. Options include: 0 = Input, unmonitored 1 = Power LED output 3 = Digital input, monitored 4 = Digital output low 5 = Digital output high	0-1, 3-5	1

**I/O Commands**

**I/O Commands**

AT Command	Name and Description	Parameter Range	Default
P0	<b>DIO10/PWM0 Configuration.</b> Configure options for the DIO10/PWM0 line of the module. Options include: 0 = Input, unmonitored 1 = RSSI 2 = PWM0 3 = Digital input, monitored 4 = Digital output low 5 = Digital output high	0-5	1
P1	<b>DIO11/PWM1 Configuration.</b> Configure options for the DIO11/PWM1 line of the module. Options include: 0 = Input, unmonitored 2 = PWM1 3 = Digital input, monitored 4 = Digital output low 5 = Digital output high	0, 2-5	0
P2	<b>DIO12 Configuration.</b> Configure options for the DIO12 line of the module. Options include: 0 = Input, unmonitored 3 = Digital input, monitored 4 = Digital output low 5 = Digital output high	0, 3-5	0
RP	<b>RSSI PWM Timer.</b> Time RSSI signal will be output after last transmission. When RP = 0xFF, output will always be on.	0 - 0xFF [x 100 ms]	2032 3.2 seconds)

**I/O Commands**

AT Command	Name and Description	Parameter Range	Default
D0	<b>AD0/DIO0 Configuration.</b> Configure options for the AD0/DIO0 line of the module. Options include: 0 = Input, unmonitored 3 = Digital input, monitored 4 = Digital output low 5 = Digital output high	0, 3-5	0
D1	<b>AD1/DIO1 Configuration.</b> Configure options for the AD1/DIO1 line of the module. Options include: 0 = Input, unmonitored 3 = Digital input, monitored 4 = Digital output low 5 = Digital output high	0, 3-5	0
D2	<b>AD2/DIO2 Configuration.</b> Configure options for the AD2/DIO2 line of the module. Options include: 0 = Input, unmonitored 3 = Digital input, monitored 4 = Digital output low 5 = Digital output high	0, 3-5	0
D3	<b>AD3/DIO3 Configuration.</b> Configure options for the AD3/DIO3 line of the module. Options include: 0 = Input, unmonitored 3 = Digital input, monitored 4 = Digital output low 5 = Digital output high	0, 3-5	0
D4	<b>AD4/DIO4 Configuration.</b> Configure options for the AD4/DIO4 line of the module. Options include: 0 = Input, unmonitored 3 = Digital input, monitored 4 = Digital output low 5 = Digital output high	0, 3-5	0
PR	Set/read the bit field that configures the internal pull-up resistor status for the I/O lines. "1" specifies the pull-up resistor is enabled. "0" specifies no pullup. Bits: 0 - DIO4/AD4 (Pin 11) 1 - AD3 / DIO3 (Pin 17) 2 - AD2 / DIO2 (Pin 18) 3 - AD1 / DIO1 (Pin 19) 4 - AD0 / DIO0 (Pin 20) 5 - RTS / DIO6 (Pin 16) 6 - DTR / SLEEP_RQ/DIO8 / DIO8 (Pin 9) 7 - DIN / Config (Pin 3) 8 - Associate / DIO5 (Pin 15) 9 - On/Sleep / DIO9 (Pin 13) 10 - DIO12 (Pin 4) 11 - PWM0 / RSSI / DIO10 (Pin 6) 12 - PWM1 / DIO11 (Pin 7) 13 - DIO7/ $\overline{\text{CTS}}$ (Pin 12) 14 - DOUT (Pin 2)	0 - 7FFF	0x3F7F

**Diagnostics**

**Diagnostics Commands**

AT Command	Name and Description	Parameter Range	Default
VR	<b>Firmware Version.</b> Read firmware version of the module.	0 - 0xFFFF [read-only]	Firmware-set
HV	<b>Hardware Version.</b> Read hardware version of the module.	0 - 0xFFFF [read-only]	Factory-set
ER	<b>RF Errors</b> Read the number of times the RF receiver detected a CRC or length error. When the value reaches 0xffff, it stays there.	n/a	n/a
GD	<b>Good packets</b> Read the number of good frames with valid MAC headers that are received on the RF interface. When the value reaches 0xffff, it stays there.	n/a	n/a
RC	<b>RSSI for channel</b> Reads the DBM level of the designated channel.	0 to 11	n/a

**Diagnostics Commands**

AT Command	Name and Description	Parameter Range	Default
RP	<b>RSSI PWM timer</b> Set or read the time that the RSSI output (indicating signal strength) will remain active after the last reception. Time units are measured in tenths of seconds	1 to 0xFF	0x20 = 3.2 seconds
TR	<b>Transmission Errors</b> Read the number of MAC frames that exhaust MAC retries without ever receiving a MAC acknowledgement message from the adjacent node. When the value reaches 0xffff, it stays there.	n/a	n/a

**AT Command Options**

**AT Command Options Commands**

AT Command	Name and Description	Parameter Range	Default
CT	<b>Command Mode Timeout.</b> Set/Read the period of inactivity (no valid commands received) after which the RF module automatically exits AT Command Mode and returns to Idle Mode.	2 - 0xFFFF [x 100 ms]	0x64 (100d)
CN	<b>Exit Command Mode.</b> Explicitly exit the module from AT Command Mode.	--	--
GT	<b>Guard Times.</b> Set required period of silence before and after the Command Sequence Characters of the AT Command Mode Sequence (GT + CC + GT). The period of silence is used to prevent inadvertent entrance into AT Command Mode.	0 to 0xFFFF	0x3E8 (1000d)
CC	<b>Command Character.</b> Set or read the character to be used between guard times of the AT Command Mode Sequence. The AT Command Mode Sequence causes the radio modem to enter Command Mode (from Idle Mode).	0 - 0xFF	0x2B

**Node Identification**

**Node Identification Commands**

AT Command	Name and Description	Parameter Range	Default
ID	<b>PAN ID.</b> Set or read the user network address. Nodes must have the same network address to communicate. Changes to ID should be written to non-volatile memory using the WR command.	0x0000 to 0x7FFF	0x7FFF
NT	<b>Node Discover Timeout.</b> Set/Read the amount of time a node will spend discovering other nodes when ND or DN is issued.	0x2EE0 [x 100 msec]	0x82 (130d)
NI	<b>Node Identifier.</b> Stores a string identifier. The string accepts only printable ASCII data. In AT Command Mode, the string can not start with a space. A Carriage return ends the command. Command will automatically end when maximum bytes for the string have been entered. This string is returned as part of the ATND (Network Discover) command. This identifier is also used with the ATDN (Destination Node) command. .	up to 20 byte ASCII string	a space character
DN	<b>Discover Node - Destination Node.</b> Resolves an NI (Node Identifier) string to a physical address (casesensitive). The following events occur after the destination node is discovered:  <AT Firmware> 1. DL & DH are set to the extended (64-bit) address of the module with the matching NI (Node Identifier) string. 2. OK (or ERROR)r is returned. 3. Command Mode is exited to allow immediate communication <API Firmware> The 64-bit extended addresses is returned in an API Command Response frame. If there is no response from a module within (NT * 100) milliseconds or a parameter is not specified (left blank), the command is terminated and an "ERROR" message is returned. In the case of an ERROR, Command Mode is not exited.	20 byte ascii string	

**Node Identification Commands**

AT Command	Name and Description	Parameter Range	Default
ND	<p>Node Discover - Node Discover. Discovers and reports all RF modules found. The following information is reported for each module discovered.</p> <p>0xFFFE&lt;CR&gt;                      SH&lt;CR&gt;                      SL&lt;CR&gt;                      NI&lt;CR&gt; (Variable length)                      PARENT_NETWORK ADDRESS (2 Bytes)&lt;CR&gt;                      DEVICE_TYPE&lt;CR&gt; (1 Byte: 0=Coord, 1=Router, 2=End Device)                      STATUS&lt;CR&gt; (1 Byte: Reserved)                      PROFILE_ID&lt;CR&gt; (2 Bytes)                      MANUFACTURER_ID&lt;CR&gt; (2 Bytes)                      &lt;CR&gt;</p> <p>After (NT * 100) milliseconds, the command ends by returning a &lt;CR&gt;. ND also accepts a Node Identifier (NI) as a parameter (optional). In this case, only a module that matches the supplied identifier will respond. If ND is sent through the API, each response is returned as a separate AT_CMD_Response packet. The data consists of the above listed bytes without the carriage return delimiters. The NI string will end in a "0x00" null character.</p>		

**Sleep Commands**

AT Command	Name and Description	Parameter Range	Default
SM	Sleep Mode.	0 (Normal), 4 (cyclic sleep)	0
SO	<p>Sleep Options.</p> <p>Options include:                      0 bit = Preferred sleep coordinator.                      All other bits are reserved.</p>	0 - 0xFF	0
ST	<p>Wake Time</p> <p>Units of msec, represented in hex.</p> <p>Note: The minimum valid value for ST is a function of SP, NN, and NH.                      If the user attempts to set the value of ST too low, it will be increased automatically to a minimum effective value.</p>	0x36EE80 (1 hour)	0x7D0 (2 seconds)
SP	<p>Sleep Time</p> <p>Units of 10 milliseconds, represented in hex. The value of ST will be adjusted upwards</p>	1 -23280 (4 hours)	0xC8 (2 sec)

**DigiMesh**

**Mesh Commands: Network Level Commands**

AT Command	Name and Description	Parameter Range	Default
NH	<b>Network Hops</b> Set or read the maximum number of hops expected to be seen in a network route. This value doesn't limit the number of hops allowed, but it is used to calculate timeouts waiting for network acknowledgements.	1 to 0xFF	7
NN	<b>Network Delay Slots</b> Set or read the maximum random number of network delay slots before rebroadcasting a network packet. One network delay slot is approximately 66ms.	0 to 0x0A	3
NQ	<b>Network Route Requests</b> Set or read the maximum number of route discovery retries allowed to find a path to the destination node. If NQ is zero, RREQ will only be sent once.	0 to 0x0A	3
MR	<b>Mesh Network Retries</b> Set or read the maximum number of network packet delivery attempts. If MR is non-zero, packets sent will request a network acknowledgement, and can be resent up to NR+1 times if no acknowledgements are received.]	0 to 7	1





**Data bytes that need to be escaped:**

- 0x7E – Frame Delimiter
- 0x7D – Escape
- 0x11 – XON
- 0x13 – XOFF

**Example** - Raw UART Data Frame (before escaping interfering bytes):  
 0x7E 0x00 0x02 0x23 0x11 0xCB

0x11 needs to be escaped which results in the following frame:  
 0x7E 0x00 0x02 0x23 0x7D 0x31 0xCB

Note: In the above example, the length of the raw data (excluding the checksum) is 0x0002 and the checksum of the non-escaped data (excluding frame delimiter and length) is calculated as:  
 $0xFF - (0x23 + 0x11) = (0xFF - 0x34) = 0xCB$ .

**Checksum**

To test data integrity, a checksum is calculated and verified on non-escaped data.

**To calculate:** Not including frame delimiters and length, add all bytes keeping only the lowest 8 bits of the result and subtract the result from 0xFF.

**To verify:** Add all bytes (include checksum, but not the delimiter and length). If the checksum is correct, the sum will equal 0xFF.

**API Frames**

Frame data of the UART data frame forms an API-specific structure as follows:

UART Data Frame & API-specific Structure:

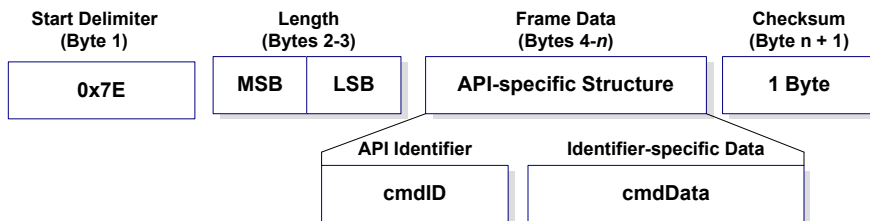

The cmdID frame (API-identifier) indicates which API messages will be contained in the cmdData frame (Identifier-specific data). Note that multi-byte values are sent big endian. The modules support the following API frames:

**API Frame Names and Values**

API Frame Names	Values
Modem Status	0x8A
AT Command	0x08
AT Command - Queue Parameter Value	0x09
AT Command Response	0x88
Remote Command Request	0x17
Remote Command Response	0x97
Transmit Request	0x10
Explicit Addressing Command Frame	0x11
Transmit Status	0x8B
Receive Packet (AO=0)	0x90
Explicit Rx Indicator (AO=1)	0x91

## Modem Status

API Identifier Value: (0x8A)

RF module status messages are sent from the module in response to specific conditions.

### Modem Status Frames

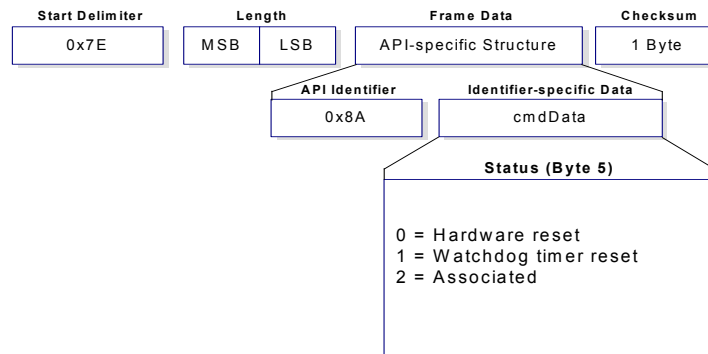

## AT Command

API Identifier Value: (0x08)

Allows for module parameter registers to be queried or set.

### AT Command Frames

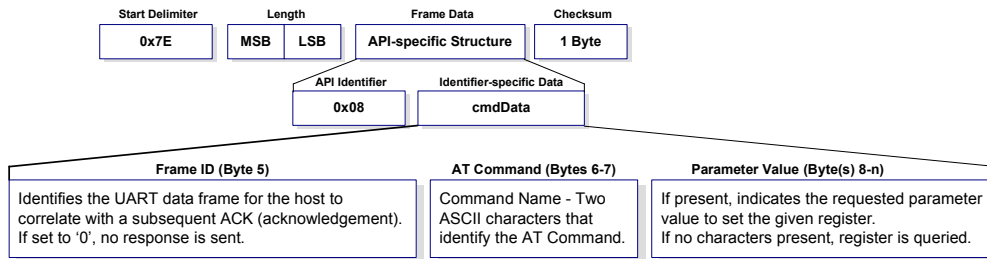

Example: API frames when reading the NJ parameter value of the module.

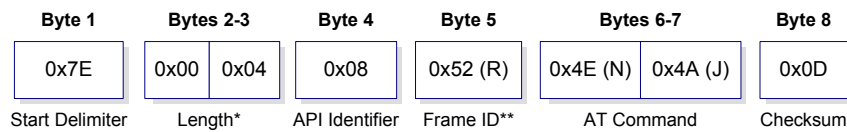

\* Length [Bytes] = API Identifier + Frame ID + AT Command

\*\* "R" value was arbitrarily selected.

Example: API frames when modifying the NJ parameter value of the module.

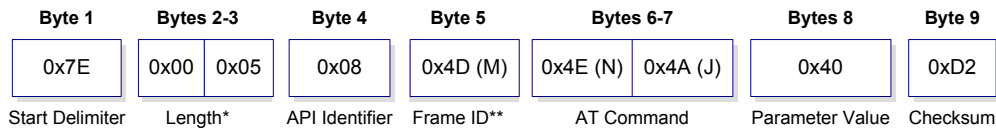

\* Length [Bytes] = API Identifier + Frame ID + AT Command + Parameter Value

\*\* "M" value was arbitrarily selected.

A string parameter used with the NI (Node Identifier), ND (Node Discover) and DH (Destination Address High) command is terminated with a 0x00 character.

## AT Command - Queue Parameter Value

API Identifier Value: (0x09)

This API type allows module parameters to be queried or set. In contrast to the "AT Command" API type, new parameter values are queued and not applied until either the "AT Command" (0x08) API type or the AC (Apply Changes) command is issued. Register queries (reading parameter values) are returned immediately.

### AT Command Frames

(Note that frames are identical to the "AT Command" API type except for the API identifier.)

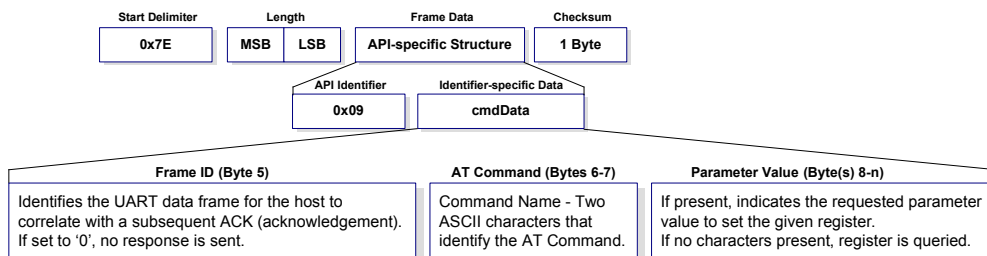

## AT Command Response

API Identifier Value: (0x88)

Response to previous command.

In response to an AT Command message, the module will send an AT Command Response message. Some commands will send back multiple frames (for example, the ND (Node Discover) command).

AT Command Response Frames.

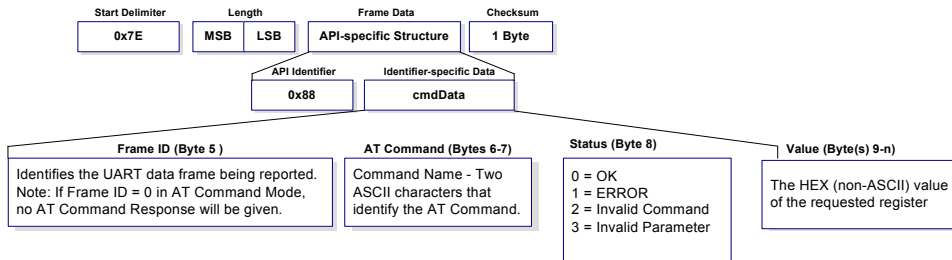

## Remote AT Command Request

API Identifier Value: (0x17)

Allows for module parameter registers on a remote device to be queried or set

Remote AT Command Request

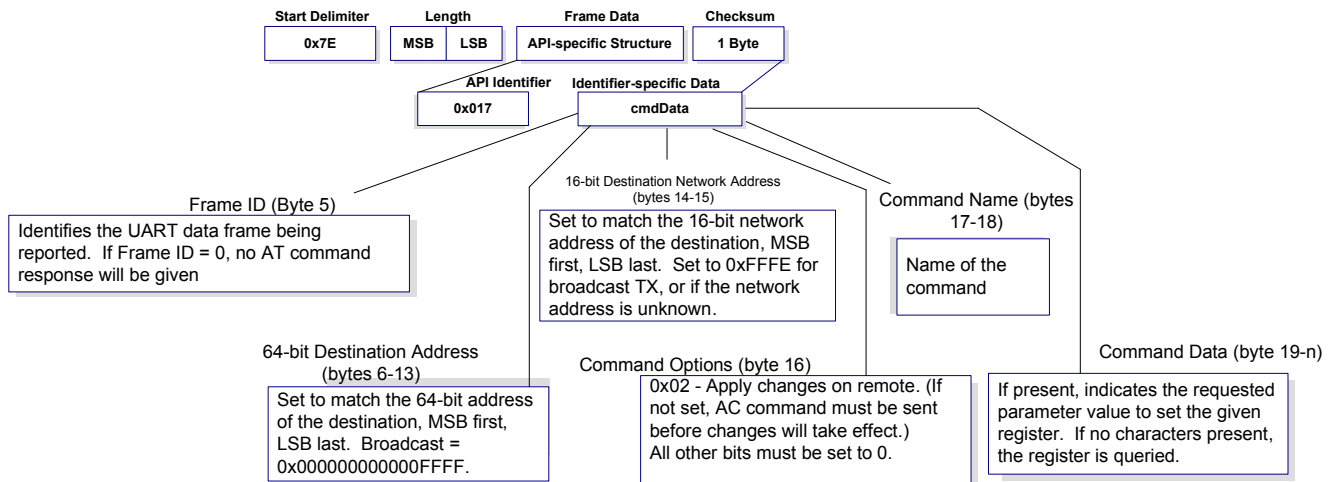

## Remote Command Response

API Identifier Value: (0x97)

If a module receives a remote command response RF data frame in response to a Remote AT Command Request, the module will send a Remote AT Command Response message out the UART. Some commands may send back multiple frames--for example, Node Discover (ND) command.

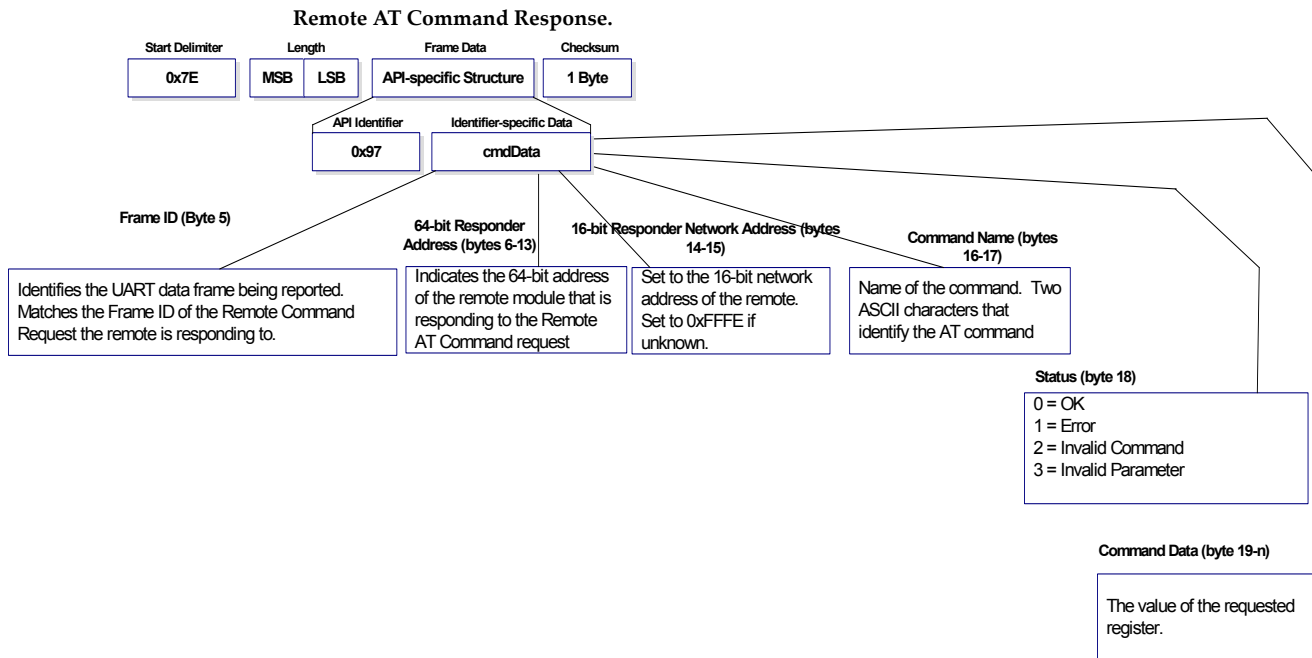

## Transmit Request

API Identifier Value: (0x10) A TX Request message will cause the module to send RF Data as an RF Packet. TX Packet Frames

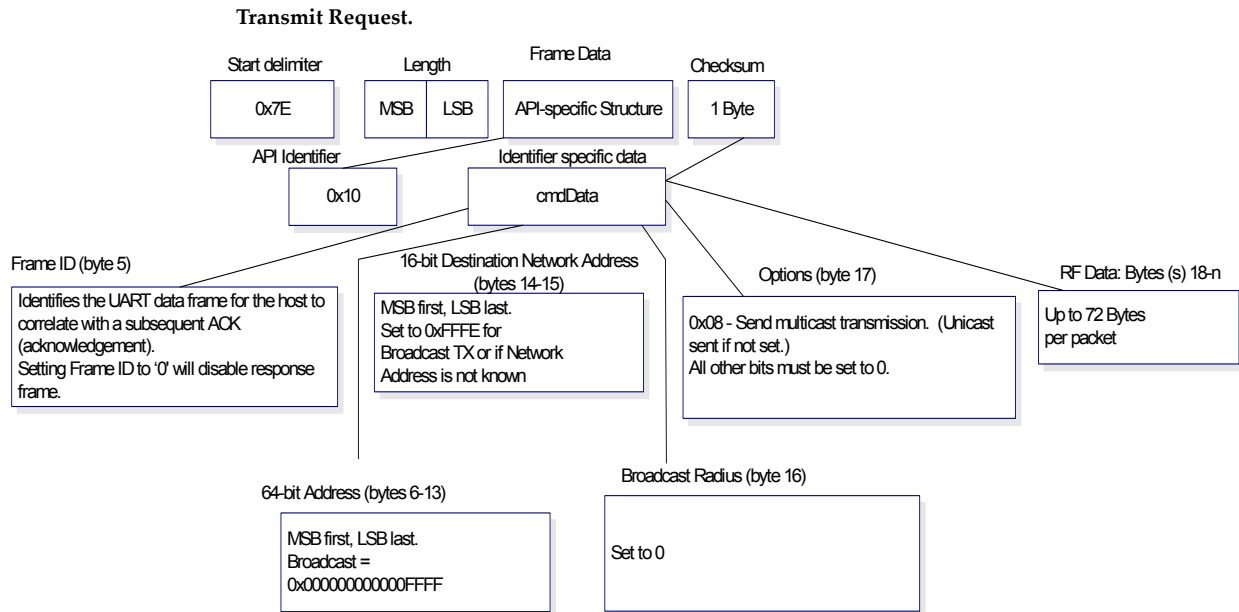

**Explicit Addressing Command Frame**

API Identifier Value: (0x11)

Allows application layer fields (endpoint and cluster ID) to be specified for a data transmission.

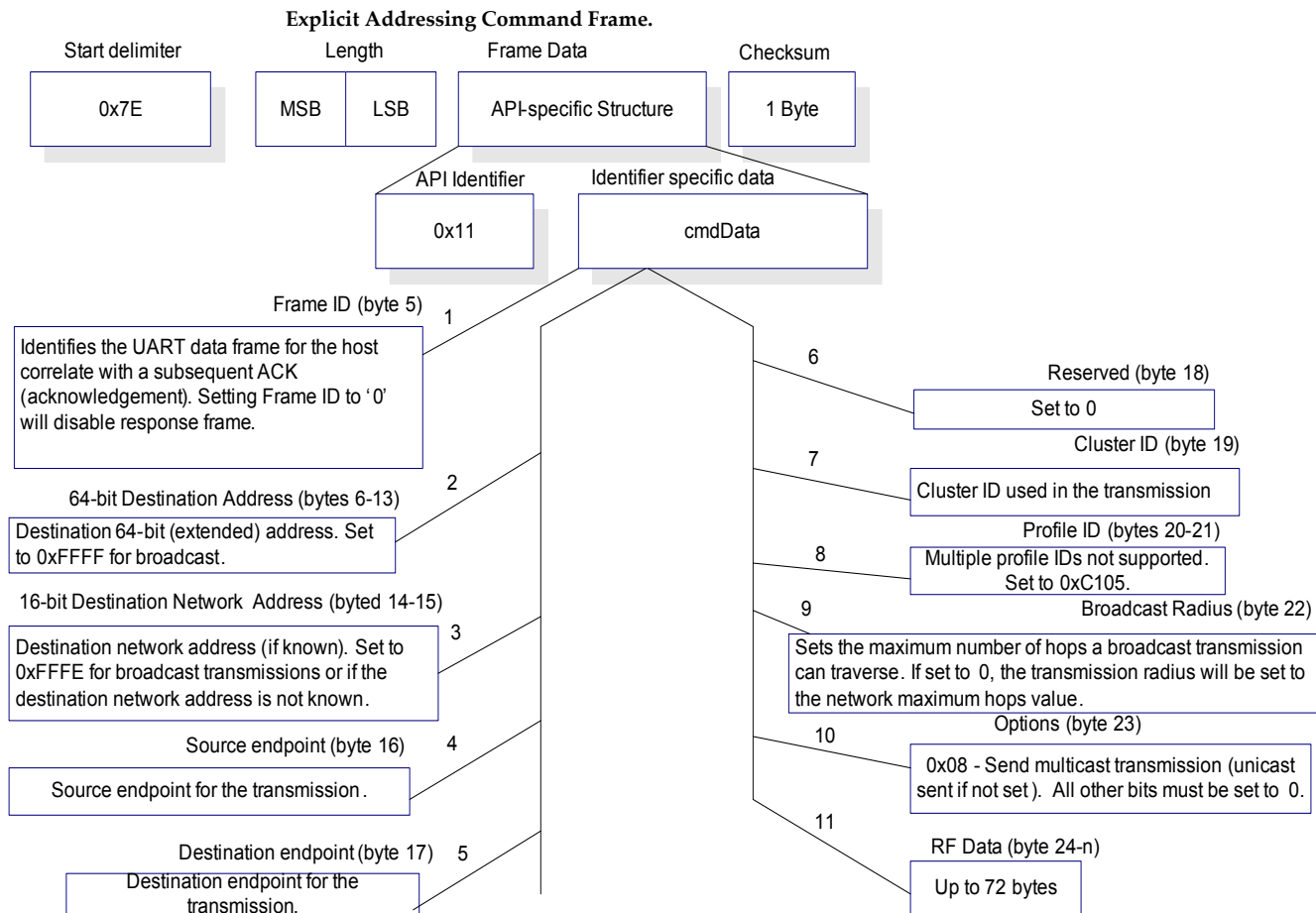

### Transmit Status

API Identifier Value: 0x8B

When a TX Request is completed, the module sends a TX Status message. This message will indicate if the packet was transmitted successfully or if there was a failure.

#### TX Status Frames

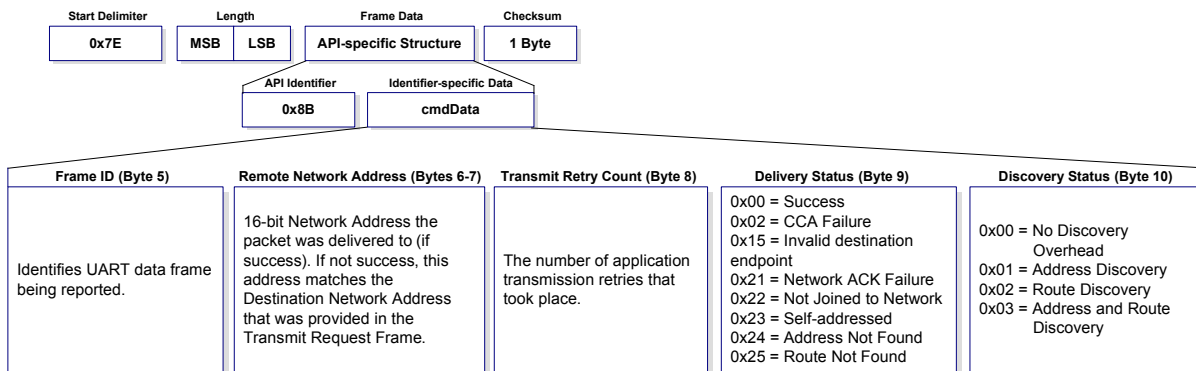

### Receive Packet

API Identifier Value: (0x90)

When the module receives an RF packet, it is sent out the UART using this message type.

#### RX Packet Frames

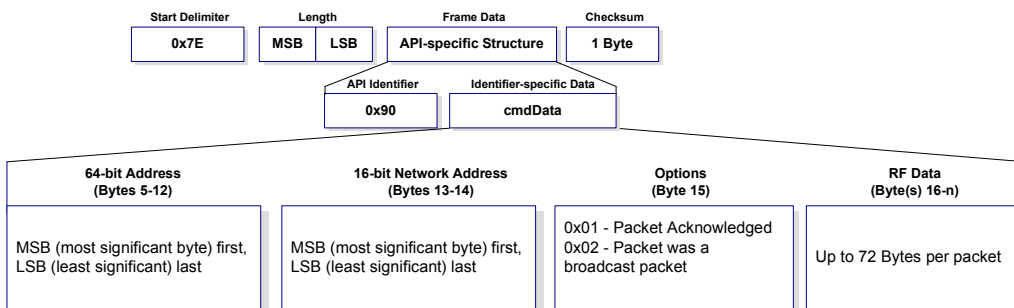



**Explicit Rx Indicator**

API Identifier Value:(0x91)

When the modem receives a RF packet it is sent out the UART using this message type (when AO=1).

**Explicit Rx Indicators**

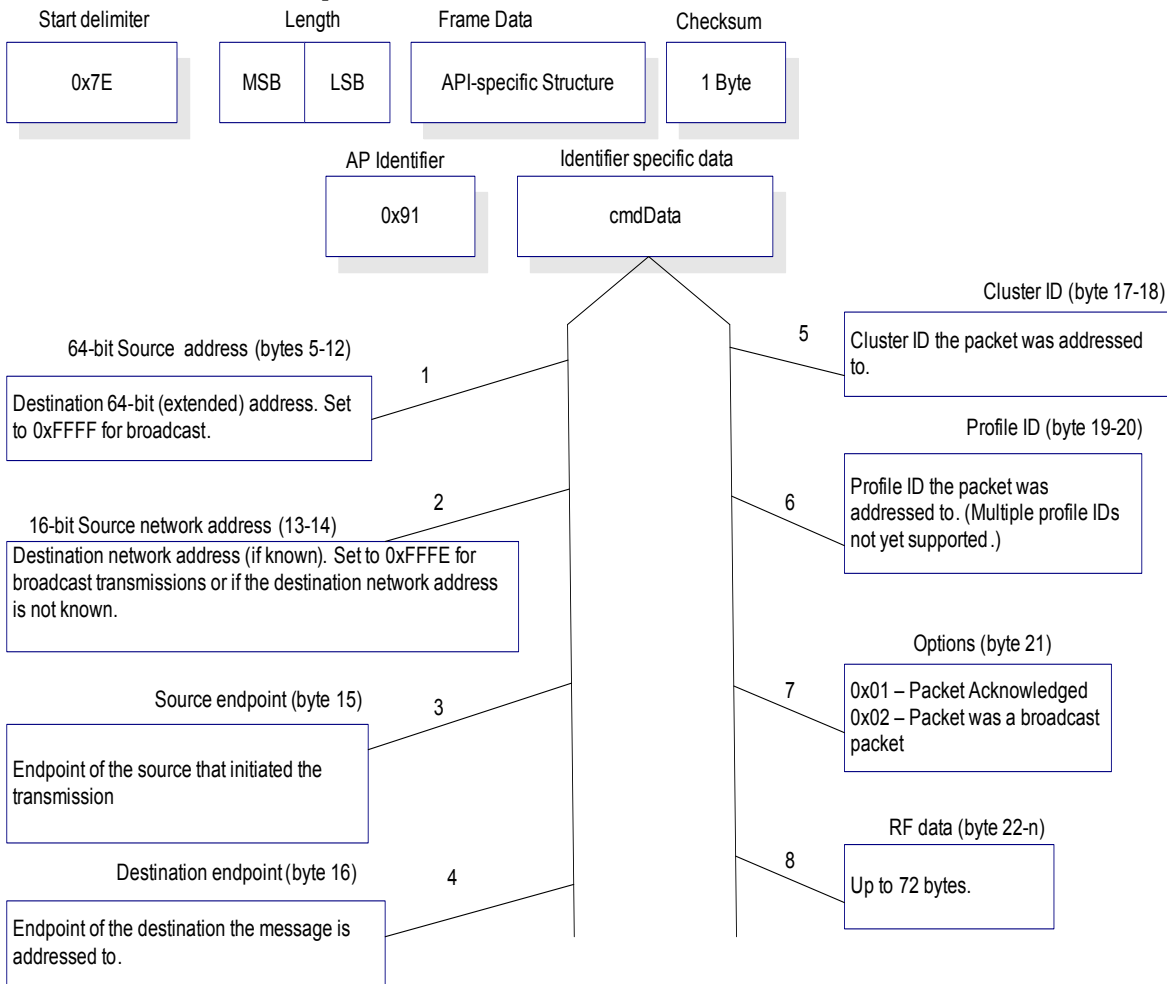

# Appendix A: Definitions

## Definitions

### Terms and Definitions

PAN	Personal Area Network - A data communication network that includes a coordinator and one or more routers/end devices.
Network Address	The 16-bit address is used for compatibility and has an address of 0xFFFE

### DigiMesh Protocol

Election	An election takes place to resolve which node will function as the network's sleep coordinator if multiple nodes nominate themselves at the same time,
Hopping	One direct host-to-host connection forming part of the route between hosts
Network Identifier	A string used to identify a node, apart from its address
Nomination	Nomination is the process where a node becomes a sleep coordinator.
Route Request	Broadcast transmission sent by a coordinator or router throughout the network in attempt to establish a route to a destination node.
Route Reply	Unicast transmission sent back to the originator of the route request. It is initiated by a node when it receives a route request packet and its address matches the Destination Address in the route request packet.
Route Discovery	The process of establishing a route to a destination node when one does not exist in the Routing Table. It is based on the AODV (Ad-hoc On-demand Distance Vector routing) protocol.
Sleep coordinator	Node used to send synch messages in a cyclic sleeping network.
Synch message	A transmission used in a cyclic sleeping network to maintain synchronization.

# Appendix B: Agency Certifications

---

## United States (FCC)

---

XBee/XBee-PRO DigiMesh 2.4 RF Modules comply with Part 15 of the FCC rules and regulations. Compliance with the labeling requirements, FCC notices and antenna usage guidelines is required.

To fulfill FCC Certification requirements, the OEM must comply with the following regulations:

1. The system integrator must ensure that the text on the external label provided with this device is placed on the outside of the final product [Figure A-01].
2. XBee/XBee-PRO DigiMesh 2.4 RF Modules may only be used with antennas that have been tested and approved for use with this module [refer to the antenna tables in this section].

### OEM Labeling Requirements

---



**WARNING:** The Original Equipment Manufacturer (OEM) must ensure that FCC labeling requirements are met. This includes a clearly visible label on the outside of the final product enclosure that displays the contents shown in the figure below.

#### Required FCC Label for OEM products containing the XBee/XBee-PRO DigiMesh 2.4 RF Module

Contains FCC ID: OUR-XBEE/OUR-XBEEPRO\*

The enclosed device complies with Part 15 of the FCC Rules. Operation is subject to the following two conditions: *(i.)* this device may not cause harmful interference and *(ii.)* this device must accept any interference received, including interference that may cause undesired operation.

\* The FCC ID for the XBee is "OUR-XBEE". The FCC ID for the XBee-PRO is "OUR-XBEEPRO".

### FCC Notices

---

**IMPORTANT:** The XBee/XBee-PRO DigiMesh 2.4 OEM RF Module has been certified by the FCC for use with other products without any further certification (as per FCC section 2.1091). Modifications not expressly approved by Digi could void the user's authority to operate the equipment.

**IMPORTANT:** OEMs must test final product to comply with unintentional radiators (FCC section 15.107 & 15.109) before declaring compliance of their final product to Part 15 of the FCC Rules.

**IMPORTANT:** The RF module has been certified for remote and base radio applications. If the module will be used for portable applications, the device must undergo SAR testing.

This equipment has been tested and found to comply with the limits for a Class B digital device, pursuant to Part 15 of the FCC Rules. These limits are designed to provide reasonable protection against harmful interference in a residential installation. This equipment generates, uses and can radiate radio frequency energy and, if not installed and used in accordance with the instructions, may cause harmful interference to radio communications. However, there is no guarantee that interference will not occur in a particular installation.

If this equipment does cause harmful interference to radio or television reception, which can be determined by turning the equipment off and on, the user is encouraged to try to correct the interference by one or more of the following measures: Re-orient or relocate the receiving antenna, Increase the separation between the equipment and receiver, Connect equipment and receiver to outlets on different circuits, or Consult the dealer or an experienced radio/TV technician for help.

### FCC-Approved Antennas (2.4 GHz)

---

XBee/XBee-PRO RF Modules can be installed using antennas and cables constructed with standard connectors (Type-N, SMA, TNC, etc.) if the installation is performed professionally and according to FCC guidelines. For installations not performed by a professional, non-standard connectors (RPSMA, RPTNC, etc) must be used.

The modules are FCC-approved for fixed base station and mobile applications on channels 0x0B - 0x1A (XBee) and 0x0C - 0x17 (XBee-PRO). If the antenna is mounted at least 20cm (8 in.) from nearby persons, the application is

considered a mobile application. Antennas not listed in the table must be tested to comply with FCC Section 15.203 (Unique Antenna Connectors) and Section 15.247 (Emissions).

**XBee OEM RF Modules (1 mW):** XBee Modules have been tested and approved for use with all of the antennas listed in the tables below (Cable-loss IS NOT required).

**XBee-PRO OEM RF Modules (60 mW):** XBee-PRO Modules have been tested and approved for use with the antennas listed in the tables below (Cable-loss IS required when using antennas listed in the second table below).

The antennas in the tables below have been approved for use with the XBee/XBee-PRO DigiMesh 2.4 RF module. Digi does not carry all of these antenna variants. Contact Digi Sales for available antennas.

**Antennas approved for use with the XBee/XBee-PRO DigiMesh 2.4 RF Modules (Cable-loss is not required.)**

Part Number	Type (Description)	Gain	Application*	Min. Separation
A24-HASM-450	Dipole (Half-wave articulated RPSMA - 4.5")	2.1 dBi	Fixed/Mobile	20 cm
A24-HABSM	Dipole (Articulated RPSMA)	2.1 dBi	Fixed	20 cm
A24-HABUF-P5I	Dipole (Half-wave articulated bulkhead mount U.F.L. w/ 5" pigtail)	2.1 dBi	Fixed	20 cm
A24-HASM-525	Dipole (Half-wave articulated RPSMA - 5.25")	2.1 dBi	Fixed/Mobile	20 cm
A24-QI	Monopole (Integrated whip)	1.5 dBi	Fixed	20 cm

**Antennas approved for use with the XBee RF Modules (Cable-loss is required)**

Part Number	Type (Description)	Gain	Application*	Min. Separation	Required Cable-loss
<b>Omni-Directional Class Antennas</b>					
A24-Y6NF	Yagi (6-element)	8.8 dBi	Fixed	2 m	1.7 dB
A24-Y7NF	Yagi (7-element)	9.0 dBi	Fixed	2 m	1.9 dB
A24-Y9NF	Yagi (9-element)	10.0 dBi	Fixed	2 m	2.9 dB
A24-Y10NF	Yagi (10-element)	11.0 dBi	Fixed	2 m	3.9 dB
A24-Y12NF	Yagi (12-element)	12.0 dBi	Fixed	2 m	4.9 dB
A24-Y13NF	Yagi (13-element)	12.0 dBi	Fixed	2 m	4.9 dB
A24-Y15NF	Yagi (15-element)	12.5 dBi	Fixed	2 m	5.4 dB
A24-Y16NF	Yagi (16-element)	13.5 dBi	Fixed	2 m	6.4 dB
A24-Y16RM	Yagi (16-element, RPSMA connector)	13.5 dBi	Fixed	2 m	6.4 dB
A24-Y18NF	Yagi (18-element)	15.0 dBi	Fixed	2 m	7.9 dB
<b>Omni-Directional Class Antennas</b>					
A24-C1	Surface Mount	-1.5 dBi	Fixed/Mobile	20 cm	-
A24-F2NF	Omni-directional (Fiberglass base station)	2.1 dBi	Fixed/Mobile	20 cm	
A24-F3NF	Omni-directional (Fiberglass base station)	3.0 dBi	Fixed/Mobile	20 cm	
A24-F5NF	Omni-directional (Fiberglass base station)	5.0 dBi	Fixed/Mobile	20 cm	
A24-F8NF	Omni-directional (Fiberglass base station)	8.0 dBi	Fixed	2 m	
A24-F9NF	Omni-directional (Fiberglass base station)	9.5 dBi	Fixed	2 m	0.2 dB
A24-F10NF	Omni-directional (Fiberglass base station)	10.0 dBi	Fixed	2 m	0.7 dB
A24-F12NF	Omni-directional (Fiberglass base station)	12.0 dBi	Fixed	2 m	2.7 dB
A24-F15NF	Omni-directional (Fiberglass base station)	15.0 dBi	Fixed	2 m	5.7 dB
A24-W7NF	Omni-directional (Base station)	7.2 dBi	Fixed	2 m	
A24-M7NF	Omni-directional (Mag-mount base station)	7.2 dBi	Fixed	2 m	
<b>Panel Class Antennas</b>					
A24-P8SF	Flat Panel	8.5 dBi	Fixed	2 m	1.5 dB
A24-P8NF	Flat Panel	8.5 dBi	Fixed	2 m	1.5 dB
A24-P13NF	Flat Panel	13.0 dBi	Fixed	2 m	6 dB
A24-P14NF	Flat Panel	14.0 dBi	Fixed	2 m	7 dB
A24-P15NF	Flat Panel	15.0 dBi	Fixed	2 m	8 dB
A24-P16NF	Flat Panel	16.0 dBi	Fixed	2 m	9 dB

**Antennas approved for use with the XBee/XBee-PRO DigiMesh 2.4 RF Modules (Cable-loss is required)**

Part Number	Type (Description)	Gain	Application*	Min. Separation	Required Cable-loss
A24-C1	Surface Mount	-1.5 dBi	Fixed/Mobile	20 cm	-
A24-Y4NF	Yagi (4-element)	6.0 dBi	Fixed	2 m	8.1 dB

Part Number	Type (Description)	Gain	Application*	Min. Separation	Required Cable-loss
A24-Y6NF	Yagi (6-element)	8.8 dBi	Fixed	2 m	10.9 dB
A24-Y7NF	Yagi (7-element)	9.0 dBi	Fixed	2 m	11.1 dB
A24-Y9NF	Yagi (9-element)	10.0 dBi	Fixed	2 m	12.1 dB
A24-Y10NF	Yagi (10-element)	11.0 dBi	Fixed	2 m	13.1 dB
A24-Y12NF	Yagi (12-element)	12.0 dBi	Fixed	2 m	14.1 dB
A24-Y13NF	Yagi (13-element)	12.0 dBi	Fixed	2 m	14.1 dB
A24-Y15NF	Yagi (15-element)	12.5 dBi	Fixed	2 m	14.6 dB
A24-Y16NF	Yagi (16-element)	13.5 dBi	Fixed	2 m	15.6 dB
A24-Y16RM	Yagi (16-element, RPSMA connector)	13.5 dBi	Fixed	2 m	15.6 dB
A24-Y18NF	Yagi (18-element)	15.0 dBi	Fixed	2 m	17.1 dB
A24-F2NF	Omni-directional (Fiberglass base station)	2.1 dBi	Fixed/Mobile	20 cm	4.2 dB
A24-F3NF	Omni-directional (Fiberglass base station)	3.0 dBi	Fixed/Mobile	20 cm	5.1 dB
A24-F5NF	Omni-directional (Fiberglass base station)	5.0 dBi	Fixed/Mobile	20 cm	7.1 dB
A24-F8NF	Omni-directional (Fiberglass base station)	8.0 dBi	Fixed	2 m	10.1 dB
A24-F9NF	Omni-directional (Fiberglass base station)	9.5 dBi	Fixed	2 m	11.6 dB
A24-F10NF	Omni-directional (Fiberglass base station)	10.0 dBi	Fixed	2 m	12.1 dB
A24-F12NF	Omni-directional (Fiberglass base station)	12.0 dBi	Fixed	2 m	14.1 dB
A24-F15NF	Omni-directional (Fiberglass base station)	15.0 dBi	Fixed	2 m	17.1 dB
A24-W7NF	Omni-directional (Base station)	7.2 dBi	Fixed	2 m	9.3 dB
A24-M7NF	Omni-directional (Mag-mount base station)	7.2 dBi	Fixed	2 m	9.3 dB
A24-P8SF	Flat Panel	8.5 dBi	Fixed	2 m	8.6 dB
A24-P8NF	Flat Panel	8.5 dBi	Fixed	2 m	8.6 dB
A24-P13NF	Flat Panel	13.0 dBi	Fixed	2 m	13.1 dB
A24-P14NF	Flat Panel	14.0 dBi	Fixed	2 m	14.1 dB
A24-P15NF	Flat Panel	15.0 dBi	Fixed	2 m	15.1 dB
A24-P16NF	Flat Panel	16.0 dBi	Fixed	2 m	16.1 dB
A24-P19NF	Flat Panel	19.0 dBi	Fixed	2 m	19.1 dB

\* **If using the RF module in a portable application** (For example - If the module is used in a handheld device and the antenna is less than 20cm from the human body when the device is operation): The integrator is responsible for passing additional SAR (Specific Absorption Rate) testing based on FCC rules 2.1091 and FCC Guidelines for Human Exposure to Radio Frequency Electromagnetic Fields, OET Bulletin and Supplement C. The testing results will be submitted to the FCC for approval prior to selling the integrated unit. The required SAR testing measures emissions from the module and how they affect the person.

### RF Exposure



**WARNING:** To satisfy FCC RF exposure requirements for mobile transmitting devices, a separation distance of 20 cm or more should be maintained between the antenna of this device and persons during device operation. To ensure compliance, operations at closer than this distance is not recommended. The antenna used for this transmitter must not be co-located in conjunction with any other antenna or transmitter.

The preceding statement must be included as a CAUTION statement in OEM product manuals in order to alert users of FCC RF Exposure compliance.

## Europe (ETSI)

The XBee/XBee-PRO DigiMesh 2.4 RF Module has been certified for use in several European countries. For a complete list, refer to [www.maxstream.net](http://www.maxstream.net).

If the XBee/XBee-PRO DigiMesh 2.4 RF Modules are incorporated into a product, the manufacturer must ensure compliance of the final product to the European harmonized EMC and low-voltage/safety standards. A Declaration of Conformity must be issued for each of these standards and kept on file as described in Annex II of the R&TTE Directive.

Furthermore, the manufacturer must maintain a copy of the XBee/XBee-PRO DigiMesh 2.4 user manual documentation and ensure the final product does not exceed the specified power ratings, antenna specifications, and/or installation requirements as specified in the user manual. If any of these specifications are exceeded in the final product, a submission must be made to a notified body for compliance testing to all required standards.

### OEM Labeling Requirements

The 'CE' marking must be affixed to a visible location on the OEM product.

#### CE Labeling Requirements

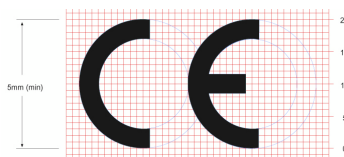

The CE mark shall consist of the initials "CE" taking the following form:

- If the CE marking is reduced or enlarged, the proportions given in the above graduated drawing must be respected.
- The CE marking must have a height of at least 5mm except where this is not possible on account of the nature of the apparatus.
- The CE marking must be affixed visibly, legibly, and indelibly.

### Restrictions

**Power Output:** "Power Output: The power output of the XBee-PRO RF Modules must not exceed 10 dBm. The power level is set using the PL command.

**France:** France imposes restrictions on the 2.4 GHz band. Go to [www.art-telecom.fr](http://www.art-telecom.fr) or contact MaxStream for more information.

**Norway:** Norway prohibits operation near Ny-Alesund in Svalbard. More information can be found at the Norway Posts and Telecommunications site ([www.npt.no](http://www.npt.no)).

### Declarations of Conformity

MaxStream has issued Declarations of Conformity for the XBee/XBee-PRO DigiMesh 2.4 RF Modules concerning emissions, EMC and safety. Files are located in the 'documentation' folder of the MaxStream CD.

#### Important Note

MaxStream does not list the entire set of standards that must be met for each country. MaxStream customers assume full responsibility for learning and meeting the required guidelines for each country in their distribution market. For more information relating to European compliance of an OEM product incorporating the XBee/XBee-PRO DigiMesh 2.4 RF Module, contact MaxStream, or refer to the following web sites:

CEPT ERC 70-03E - Technical Requirements, European restrictions and general requirements: Available at [www.ero.dk/](http://www.ero.dk/).

R&TTE Directive - Equipment requirements, placement on market: Available at [www.ero.dk/](http://www.ero.dk/).

## **Approved Antennas**

---

When integrating high-gain antennas, European regulations stipulate EIRP power maximums. Use the following guidelines to determine which antennas to design into an application.

### **XBee-PRO OEM RF Module**

---

The following antenna types have been tested and approved for use with the XBee Module:

#### **Antenna Type: Yagi**

RF module was tested and approved with 15 dBi antenna gain with 1 dB cable-loss (EIRP Maximum of 14 dBm). Any Yagi type antenna with 14 dBi gain or less can be used with no cable-loss.

#### **Antenna Type: Omni-directional**

RF module was tested and approved with 15 dBi antenna gain with 1 dB cable-loss (EIRP Maximum of 14 dBm). Any Omni-directional type antenna with 14 dBi gain or less can be used with no cable-loss.

#### **Antenna Type: Flat Panel**

RF module was tested and approved with 19 dBi antenna gain with 4.8 dB cable-loss (EIRP Maximum of 14.2 dBm). Any Flat Panel type antenna with 14.2 dBi gain or less can be used with no cable-loss.

### **XBee-PRO OEM RF Module (@ 10 dBm Transmit Power, PL parameter value must equal 0, or use International variant)**

---

The following antennas have been tested and approved for use with the embedded XBee-PRO RF Module:

- Dipole (2.1 dBi, Omni-directional, Articulated RPSMA, Digi part number A24-HABSM)
- Chip Antenna (-1.5 dBi)
- Attached Monopole Whip (1.5 dBi)

The RF modem encasement was designed to accommodate the RPSMA antenna option.

## **Canada (IC)**

---

### **Labeling Requirements**

---

Labeling requirements for Industry Canada are similar to those of the FCC. A clearly visible label on the outside of the final product enclosure must display the following text:

**Contains Model XBee Radio, IC: 4214A-XBEE**

**Contains Model XBee-PRO Radio, IC: 4214A-XBEEPRO**

The integrator is responsible for its product to comply with IC ICES-003 & FCC Part 15, Sub. B - Unintentional Radiators. ICES-003 is the same as FCC Part 15 Sub. B and Industry Canada accepts FCC test report or CISPR 22 test report for compliance with ICES-003.

## **Japan**

---

In order to gain approval for use in Japan, the XBee-PRO RF Module must contain firmware that limits its transmit power output to 10 dBm.

For a list of module part numbers approved for use in Japan, contact MaxStream [call 1-801-765-9885 or send e-mail to sales@maxstream.net].

### **Labeling Requirements**

---

A clearly visible label on the outside of the final product enclosure must display the following text:

**ID: 005NYCA0378**