

# DATA SHEET

VER:

PAGE:

1

## PRODUCT DESCRIPTION

### Standard atmospheric conditions

Unless otherwise specified. The standard range of atmospheric conditions for making measurement and tests are as follow:

Ambient temperature  $25\pm 2^{\circ}\text{C}$   
Relative humidity  $40\%\sim 70\%$

If there is no doubt the results, measurement shall be made within the following limits:

Ambient temperature  $25\pm 2^{\circ}\text{C}$   
Relative humidity :  $40\%\sim 70\%$

### Measure equipment

Electrical characteristics measured by S&A250B or equivalent.

### Crystal cutting type

The crystal is using AT CUT (thickness shear mode)

## ELECTRICAL SPECIFICATIONS

	Parameters	Symbol	Electrical Spec.	UNITS	Notes
1	Nominal Frequency	FL	$8.000\sim 11.999$	MHz	-
2	Oscillation Mode	-	Fund	-	-
3	Load Capacitance	CL	18(STD)	p F	user spec
4	Frequency Tolerance	-	$\pm 30$	ppm	at $25\pm 2^{\circ}\text{C}$
5	Operating Temperature	-	$-20\sim +70^{\circ}\text{C}$	$^{\circ}\text{C}$	-
6	Frequency Stability (reference $25^{\circ}\text{C}$ )	-	$\pm 30$	ppm	$-20\sim +70^{\circ}\text{C}$
7	Drive Level	DL	100.0	u W	-
8	Effective Resistance Rr	ESR	$< 80.0$	ohm	-
9	Shunt Capaitance C0	C0	$< 5.0$	p F	-
10	Insulation Resistance	IR	$> 500$	M-ohm	at DC 100V
11	Aging	-	$\pm 3$	ppm	1st Year
12	Reflow shift	-	$\pm 5$	ppm	at $265\pm 2^{\circ}\text{C} * 10\text{sec}$
13	Storage Temperature Range	-	$-40\sim +85^{\circ}\text{C}$	$^{\circ}\text{C}$	-
14	ESD	-	HBM $> 2000\text{V}$	$^{\circ}\text{C}$	JESD22-A114-B
15	Others	-	-	-	-

# DATA SHEET

VER:

PAGE:

2

## DIMENSIONS

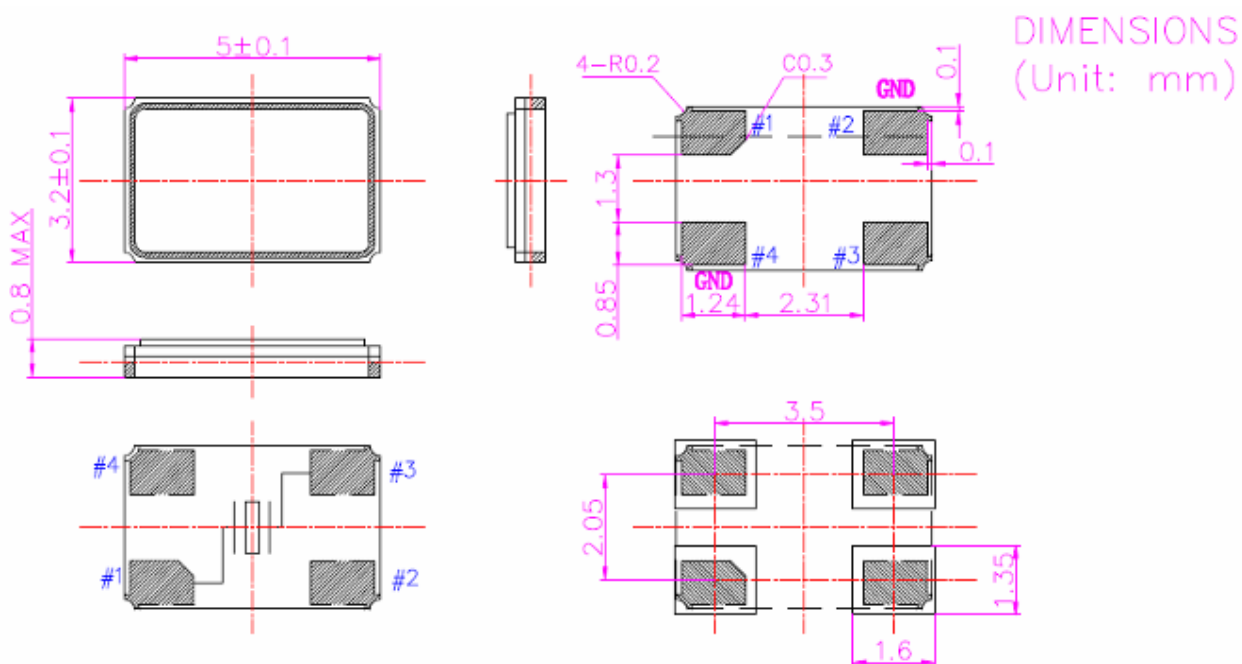

## MARKING

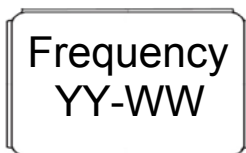

Frequency  
 YY : Years  
 WW : Weeks

## SUGGESTED REFLOW PROFILE

Total time : 200 sec. Max.  
 Solder melting point : 185 °C

