

# KAW-EL SERIES

30W WIDE INPUT RANGE

# DANUBE

## FEATURES

- 30W DIL PACKAGE
- INDUSTRY STANDARD PACKAGE
- 9-18V, 18-36V, 36-72V, 9-36V, 18-72V WIDE INPUT RANGE
- 100% BURN-IN
- HIGH EFFICIENCY
- UL 94V-0 PACKAGE MATERIAL
- CUSTOM SOLUTIONS AVAILABLE
- RoHS COMPLIANT



## OUTPUT SPECIFICATIONS

Voltage Set-point Accuracy	
Single Output	+/-2% max.
Dual Output	+/-2% max.
Capacitive load	6800uF max.
Over Voltage Protection	Built-in
Temperature Coefficient	+/-0.05°C
Ripple & Noise(20MHz BW) <sup>2</sup>	150mVp-p max.
Line Regulation <sup>3</sup>	
Single	+/-0.5% max.
Dual	+/-0.5% max.
Load Regulation <sup>5</sup>	
Single	+/-0.5% max.
Dual	+/-0.5% max.
Minimum load	10% of Full Load
Short Circuit Protection	Continuous
Short Circuit Restart	Automatic
External Trim Adj. Range	+/-10%
Over Load Protection	150% typ.
Transient Response <sup>6</sup>	500uS max.

## INPUT SPECIFICATIONS

Input Voltage Range	2:1 or 4:1 Input Range
Input Filter	Pi Network
Protection	Fuse Recommended

## GENERAL SPECIFICATIONS

Efficiency	78% min.
Isolation Voltage <sup>1</sup>	1500 VDC min.
Isolation Resistance	10 <sup>9</sup> ohms min.
Isolation Capacitance	2500pF max.
Switching Frequency	250KHz min.
MTBF <sup>4</sup>	>400,000 Hours
Weight	90g typ.
Case Material	Six-Side Shielded Case
	50.8mm*50.8mm*11mm
Potting Material	Epoxy(UL 94V-0)
Radiated Emissions	EN55022 Class A

## ENVIRONMENTAL SPECIFICATIONS

Operating Temperature	-40°C to +71°C
Case Temperature	+90°C max.
Storage Temperature	-50°C to +100°C
Humidity	95% max.
Cooling	Free-Air Convection

ALL SPECIFICATIONS TYPICAL AT NOMINAL LINE, FULL LOAD, AND 25 °C UNLESS OTHERWISE NOTED.

<sup>1</sup> For 10 seconds.

<sup>2</sup> Measured with 1uF ceramic capacitor connect to the output pins.

<sup>3</sup> High Line to Low Line.

<sup>4</sup> MIL-HDBK-217F @25 °C, Ground Benign.

<sup>5</sup> Load Regulation is for output load current change from 50% to 100%.

<sup>6</sup> 50% Step Load Change.

● **SELECTION GUIDE(1)**  
**2:1 25W-30W OUTPUT**

MODEL NUMBER	INPUT VOLTAGE (VDC)	OUTPUT VOLTAGE (VDC)	OUTPUT CURRENT (mA)	INPUT <sup>7</sup>		EFF (%) <sup>8</sup>	ISOLATION (VDC)
				CURRENT(mA)			
				FULL LOAD	NO LOAD		
KAWS-1205EL	9-18	5	6000	3125	40	80	1500
KAWS-1209EL	9-18	9	3333	3125	40	80	1500
KAWS-1212EL	9-18	12	2500	3125	40	80	1500
KAWS-1215EL	9-18	15	2000	3125	40	80	1500
KAWS-1224EL	9-18	24	1250	3125	40	80	1500
KAWD-1205EL	9-18	+/-5	+/-2500	2604	40	80	1500
KAWD-1212EL	9-18	+/-12	+/-1250	3125	40	80	1500
KAWD-1215EL	9-18	+/-15	+/-1000	3125	40	80	1500
KAWS-2403.3EL	18-36	3.3	6000	1052	20	78	1500
KAWS-2405EL	18-36	5	6000	1453	20	86	1500
KAWS-2409EL	18-36	9	3333	1560	20	80	1500
KAWS-2412EL	18-36	12	2500	1560	20	80	1500
KAWS-2415EL	18-36	15	2000	1560	20	80	1500
KAWS-2424EL	18-36	24	1250	1560	20	80	1500
KAWD-2405EL	18-36	+/-5	+/-2500	1302	20	80	1500
KAWD-2412EL	18-36	+/-12	+/-1250	1560	20	80	1500
KAWD-2415EL	18-36	+/-15	+/-1000	1560	20	80	1500
KAWS-4803.3EL	36-72	3.3	6000	529	20	78	1500
KAWS-4805EL	36-72	5	6000	781	10	80	1500
KAWS-4809EL	36-72	9	3333	781	10	80	1500
KAWS-4812EL	36-72	12	2500	781	10	80	1500
KAWS-4815EL	36-72	15	2000	781	10	80	1500
KAWS-4824EL	36-72	24	1250	781	10	80	1500
KAWD-4805EL	36-72	+/-5	+/-2500	651	10	80	1500
KAWD-4812EL	36-72	+/-12	+/-1250	781	10	80	1500
KAWD-4815EL	36-72	+/-15	+/-1000	781	10	80	1500

*Note: Other input to output voltages may be available. Please contact factory.*

<sup>7</sup> NOMINAL INPUT VOLTAGE.

<sup>8</sup> NOMINAL INPUT VOLTAGE, FULL LOAD.

● **SELECTION GUIDE(2)**  
**4:1 25W-30W OUTPUT**

MODEL NUMBER	INPUT VOLTAGE (VDC)	OUTPUT VOLTAGE (VDC)	OUTPUT CURRENT (mA)	INPUT <sup>9</sup>		EFF (%) <sup>10</sup>	ISOLATION (VDC)
				CURRENT(mA)			
				FULL LOAD	NO LOAD		
KAWS-1205TEL	9-36	5	6000	3125	30	80	1500
KAWS-1209TEL	9-36	9	3333	3125	30	80	1500
KAWS-1212TEL	9-36	12	2500	2976	30	84	1500
KAWS-2405TEL	18-72	5	6000	1488	20	84	1500
KAWS-2409TEL	18-72	9	3333	1560	20	80	1500
KAWS-2412TEL	18-72	12	2500	1560	20	80	1500
KAWS-2415TEL	18-72	15	2000	1560	20	80	1500
KAWS-2424TEL	18-72	24	1250	1560	20	80	1500

*Note: Other input to output voltages may be available. Please contact factory.*

<sup>9</sup> NOMINAL INPUT VOLTAGE.

<sup>10</sup> NOMINAL INPUT VOLTAGE, FULL LOAD.

## ● SIMPLIFIED SCHEMATIC

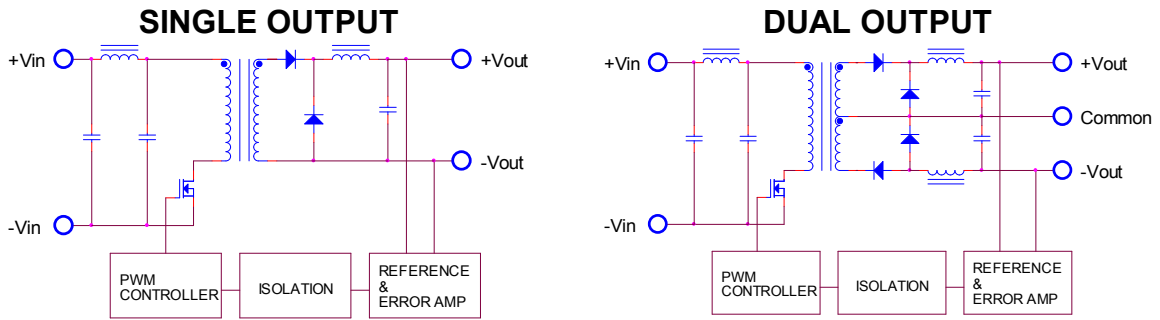

## ● MECHANICAL DIMENSIONS

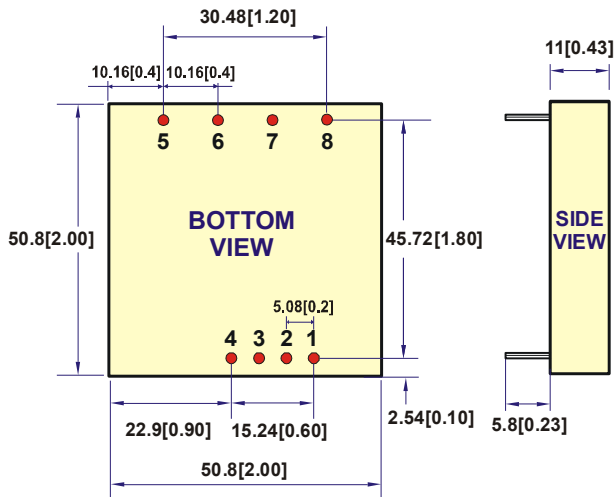

PIN	SINGLE	DUAL
1	Remote On/Off	
2	NO PIN	
3	-Vin	-Vin
4	+Vin	+Vin
5	NO PIN	+Vout
6	+Vout	Common
7	-Vout	-Vout
8	TRIM	NO PIN

All dimensions are in millimeters[inches]

Remote On/Off Control			
Control Input	PIN1	Control Common	PIN3
Control Voltage		Converter Shutdown Idle Current	10mA
ON	>+2.5VDC or Open Circuit	Logic Compatibility	CMOS or Open
OFF	<+0.8VDC or Jumper to PIN3		Collector TTL

## ● RECOMMENDED FOOTPRINT DETAILS

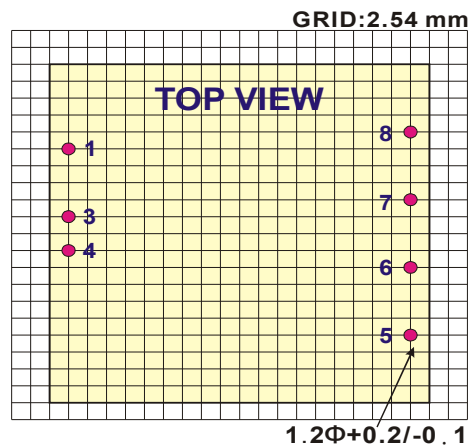

## ● TYPICAL APPLICATIONS

### SINGLE OUTPUT

#### FIXED VOLTAGE OUTPUT

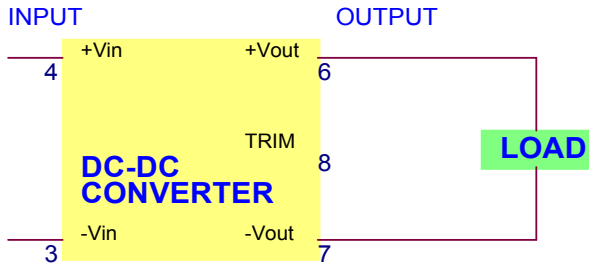

#### TRIM CONNECTIONS USING A TRIMPOT

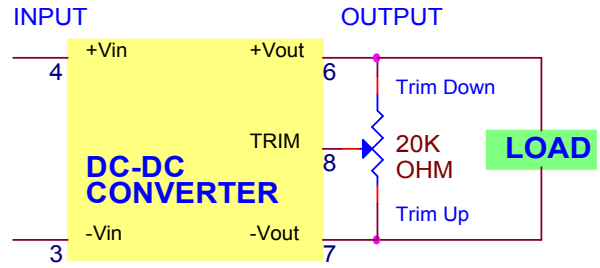

#### FIXED-VALUE TRIM DOWN RESISTOR

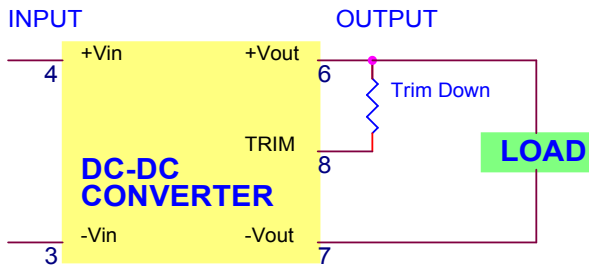

#### FIXED-VALUE TRIM UP RESISTOR

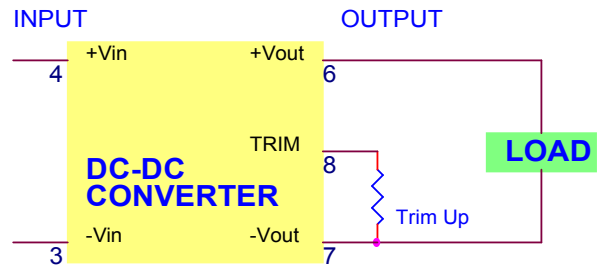

### DUAL OUTPUT

#### FIXED VOLTAGE OUTPUT

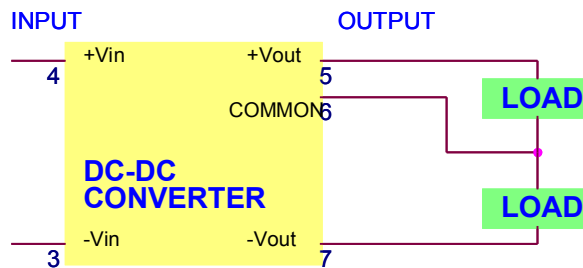

## ● TYPICAL PERFORMANCE CURVES

Specifications typical at  $T_a=25^{\circ}\text{C}$ , nominal input voltage, rated output current unless otherwise specified.

#### OUTPUT LOAD VS EFFICIENCY

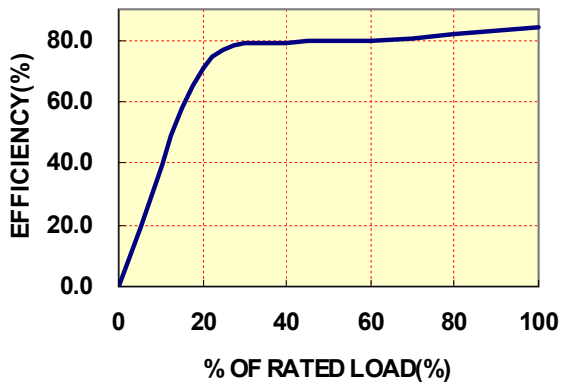

#### TEMPERATURE DERATING

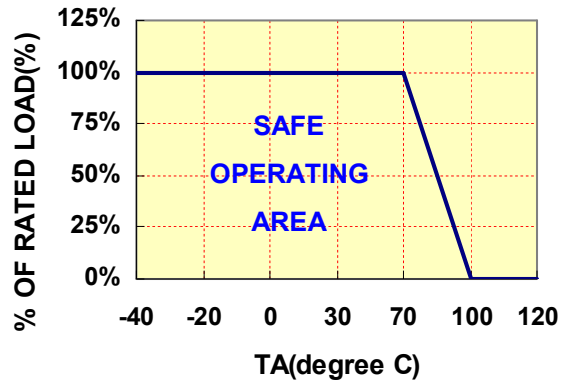

## ● INPUT FUSE SELECTION GUIDE

9-18V & 9-36V INPUT VOLTAGE(VDC)	18-36V & 18-72V INPUT VOLTAGE(VDC)	36-72V INPUT VOLTAGE(VDC)
6000mA Slow-Blow Type	3000mA Slow-Blow Type	1500mA Slow-Blow Type

**Note:** Certain applications may require the installation of external fuse in front of the input.

### KAW-EL SERIES APPLICATION NOTES:

#### EXTERNAL CAPACITANCE REQUIREMENTS:

No external capacitance is required for operation of the KAW-EL series.

To meet the reflected ripple requirements of the converter, an input impedance of less than 0.5 ohm from DC to 220 KHz is required.

External output capacitance is not required for operation; however it is recommended that 10uF tantalum and 0.1uF ceramic capacitance be selected for reduced system noise.

Additional output capacitance may be added for increased filtering, but should not exceed 2200uF.

We Can Offer EMC-Filter According To EN55011/22 Class B.

#### Negative Outputs:

A negative output voltage may be obtained by connecting the +OUT to circuit ground and connecting -OUT as the negative output.

#### Remote ON/OFF:

The remote ON/OFF pin may be left floating if this function is not use. It is recommended to drive this pin with an open collector arrangement or a relay contact. When the ON/OFF pin is pulled low with respect to the -VIN, the converter is placed in a low power drain state.

#### Output TRIM:

The TRIM pin may be used to adjust the output +/-10% from the nominal setting .this function allows adjustment for voltage drops in the system wiring. If the TRIM function is not required the pin may be left floating.

---



---

### FOR MORE INFORMATION CALL:

**Danube Enterprise Co., Ltd.**

Tel: 886-7-3755165

Fax: 886-7-3755330

E-mail: danube@ms10.hinet.net

Home Page

<http://www.danube.com.tw>

---



---