

Linear Hall Effect Sensor IC

Features:

- Wide operating range 3.0~12V, -40°C~125°C
- Flat Response to 23kHz
- High Sensitivity 4.3mV/G
- Wide sensible magnetic field range on different supplied voltage
±450 Gauss on 5V supplied voltage
±1,000 Gauss on 12V supplied voltage. Low operating current 3mA
- Two package styles TO-92S/SOT-23 available.
- Built-in temperature compensated circuit to minimize temperature's effect

Functional Description :

The W137 integrates Hall sensing element, linear amplifier, sensitivity controller and emitter follower output stage. It accurately tracks extremely small change in magnetic flux density –generally too small to operate Hall effect switch.

W137 can be applied as current sensor, tooth sensor, proximity detectors and motion detectors. As sensitive monitor of magnetic flux, it can effectively measure a system's performance with negligible system loading while providing isolation from contaminated and electrically noisy environments.

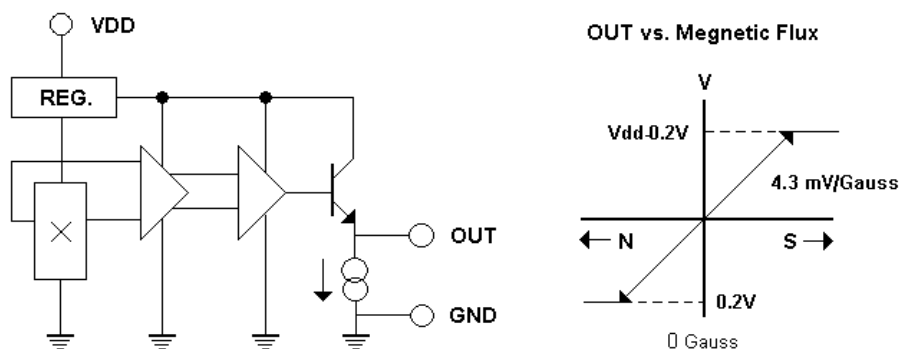

Winson reserves the right to make changes to improve reliability or manufacturability.

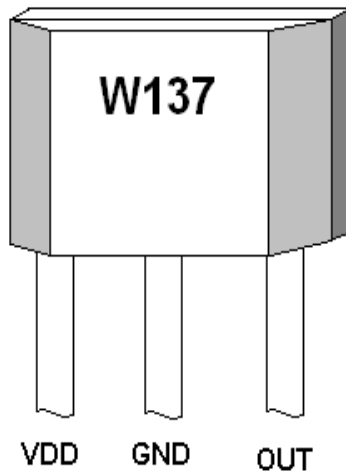

ABSOLUTE MAXIMUM RATING

Supply Voltage, V _{dd}	14V
Magnetic Flux Density, B	Unlimited
Output Driving Current	0.4mA
Operating Temperature Range	
T _a	-40°C to +125°C
Storage Temperature Range	
T _s	-65°C to +150°C
Power Dissipation P _d	
TO-92S	450mW
SOT-23	350mW

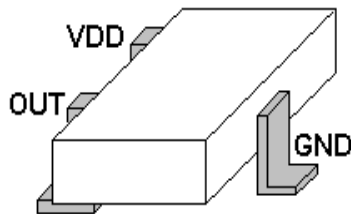

ORDER INFORMATION (Halogen Free)

WSH137-XPAN □ (TO-92S)	1: A Grade 2: B Grade
WSH137-XPCN □ (SOT-23)	
↑ Grade	

ps: (TO-92S) — 1,000/bag, (SOT-23) — 3,000/reel

Electrical Characteristics:

(T=+25°C, V_{dd}=5.0V)

Characteristic	Symbol	Test Conditions	Min	Typ	Max	Units
Supply Voltage	V _{cc}	—	3.0	—	12	V
Supply Current	I _{supply}	B=0 Gauss	—	3.0	5.0	mA
Quiescent V _{out}	V _{0G}	B=0 G (A Grade)	2.45	2.5	2.55	V
		B=0 G (B Grade)	2.4	2.5	2.6	
Sensitivity	ΔV _{out}	B= 0 to ± 400 G	3.85	4.3	4.75	mV/G
Bandwidth	BW		—	23	—	kHz
Measurable Gauss Range	MGR	V _{dd} =5V	—	±450	—	Gauss
		V _{dd} =12V	—	±1000	—	
Temperature Drift	ΔV _{out}	B=0 Gauss	—	±0.5	—	mV/°C

All output-voltage measurements are made with a voltmeter having an input impedance of at least 100kΩ

Winson reserves the right to make changes to improve reliability or manufacturability.

Package Information:

TO92S:

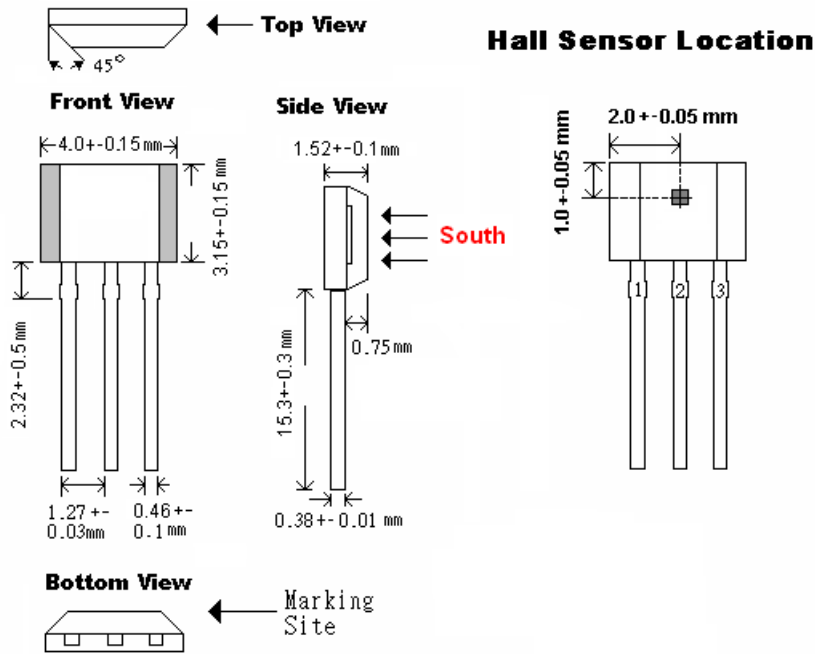

SOT23:

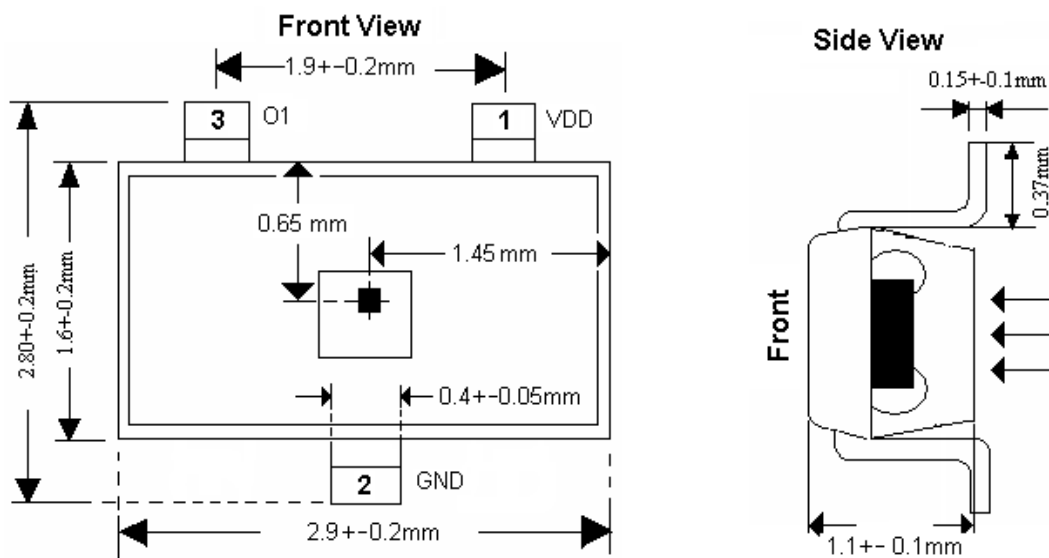

Winson reserves the right to make changes to improve reliability or manufacturability.

Characteristics Diagram:

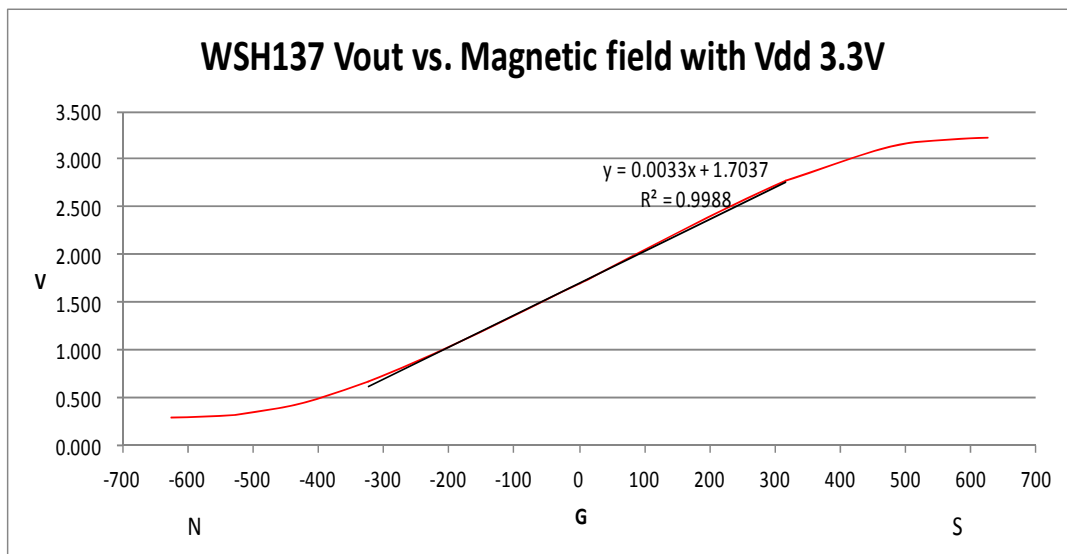
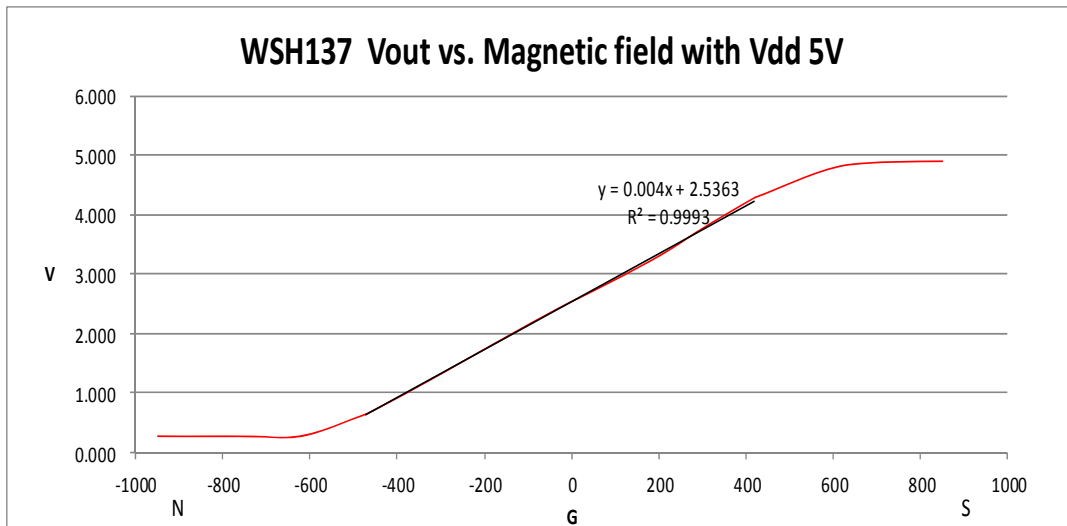
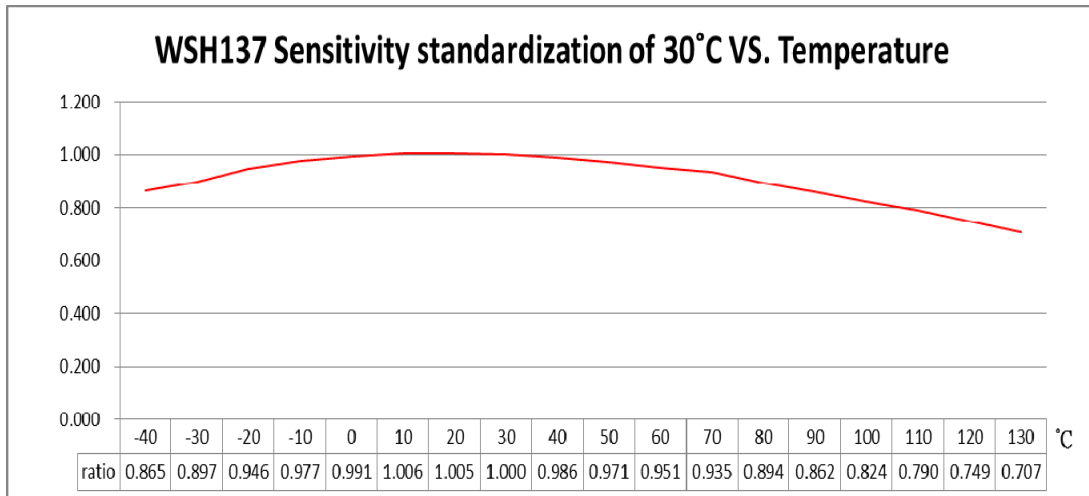

Winson reserves the right to make changes to improve reliability or manufacturability.

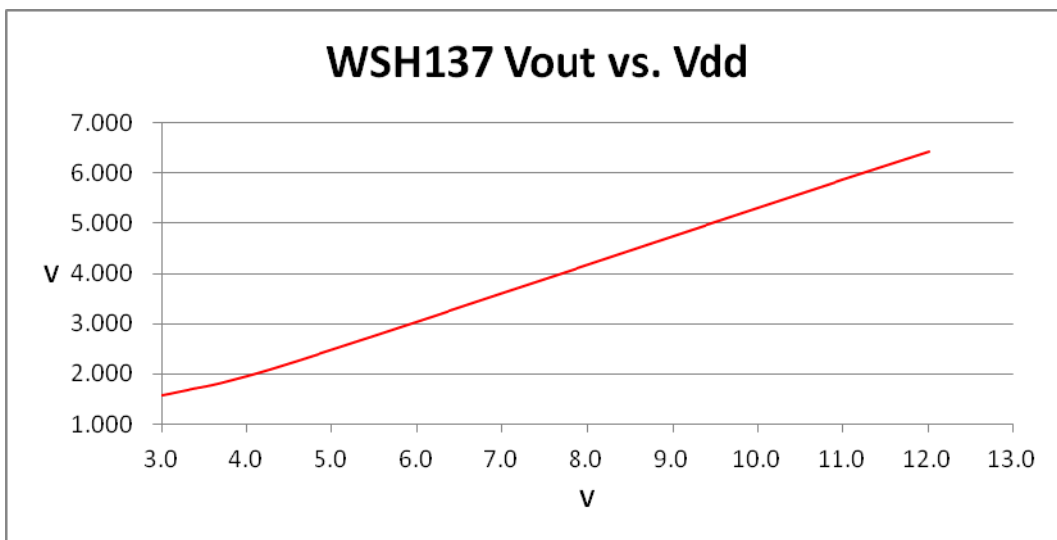
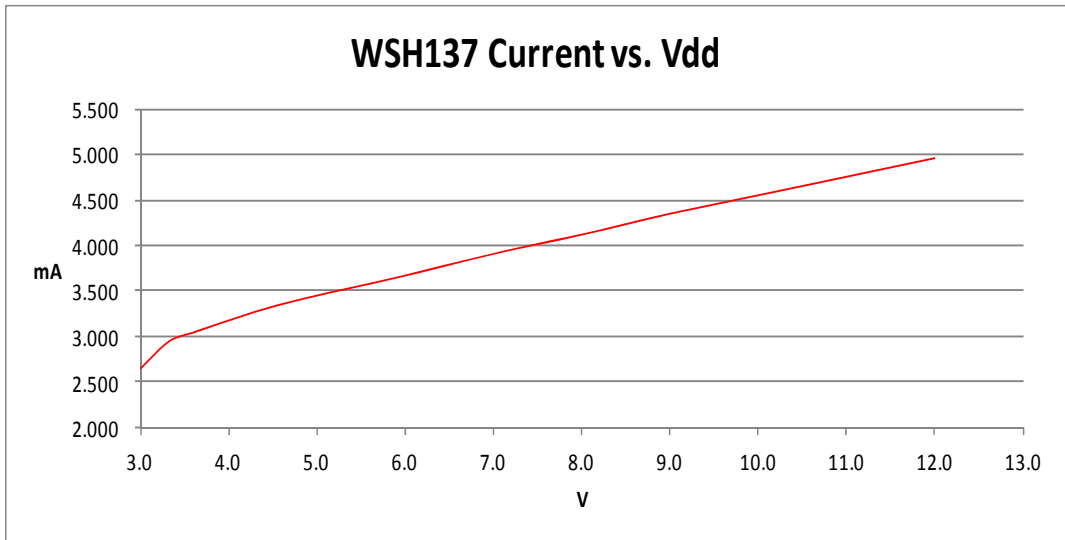
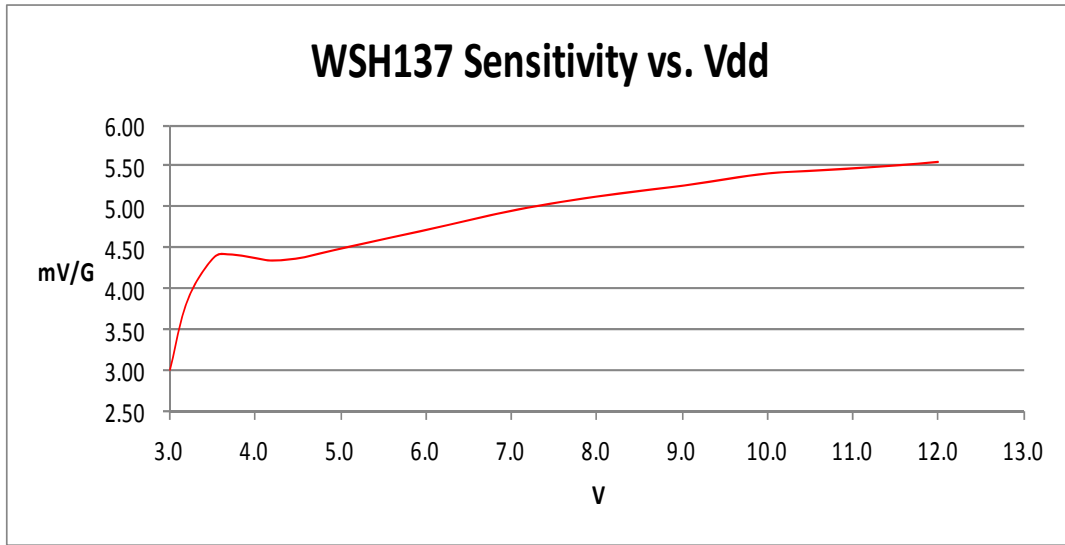

Winson reserves the right to make changes to improve reliability or manufacturability.