

Figure 2. The power amp OCL 35W R1% circuit

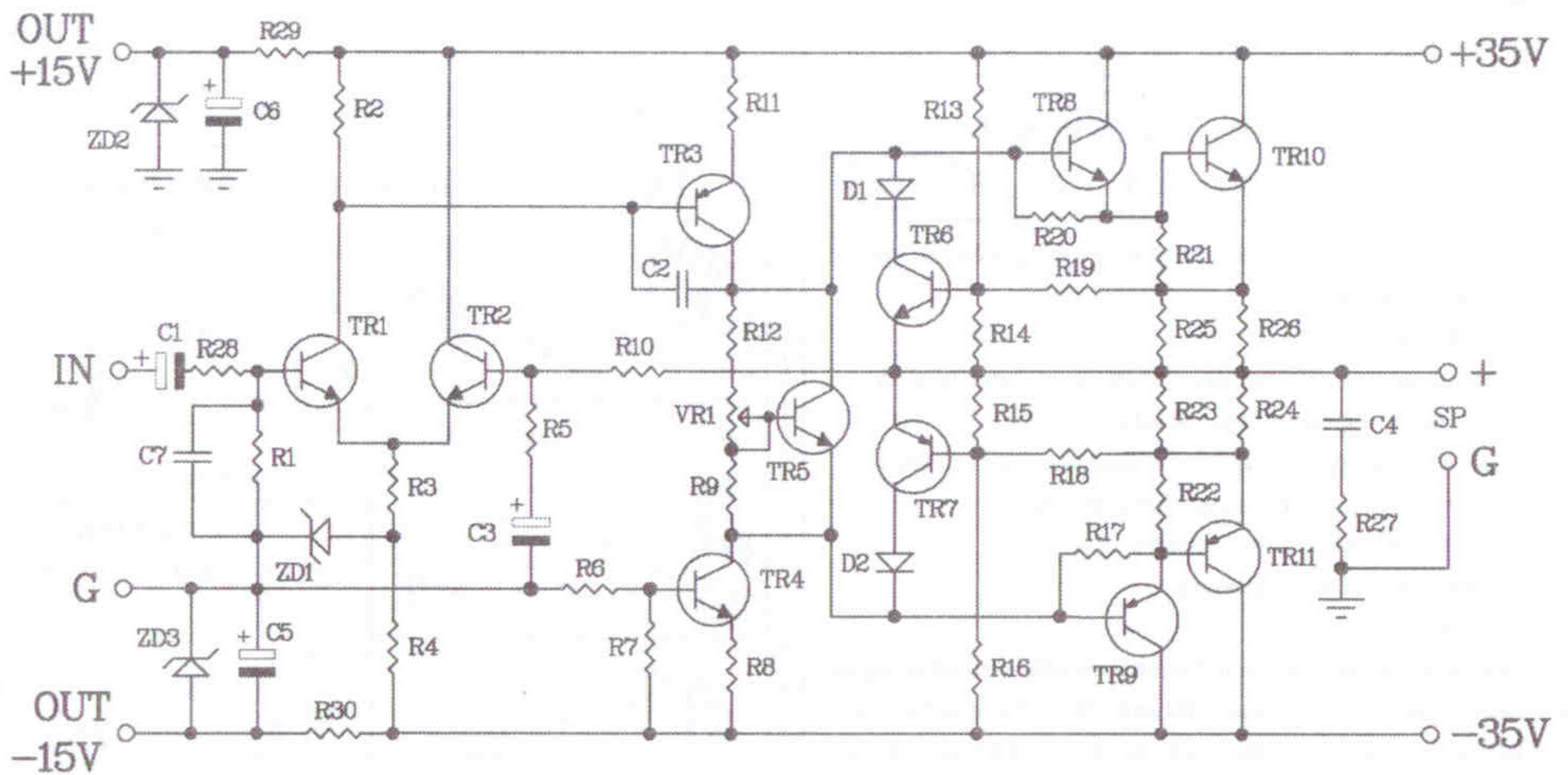

Figure 3. Connections

